

High-Precision Tuning Fork Electronic Balance

S J – E Series

Operation Manual

IMPORTANT

- To ensure safe and proper use of the balance, please read this manual carefully.
- After reading this manual, store it in a safe place near the balance, so you can review it as needed.

SHINKO DENSHI CO., LTD.

PREFACE

Thank you for purchasing an SJ Series electronic balance. This is a precision instrument equipped with exacting mechanisms in a compact body. The SJ series provides enhanced functions, including a counting mode for stock control of parts, a percentage mode for comparative measurements given in percentages, and a limit function for measuring constant quantities by consecutive weighings. Despite its many functions, the balance is easy to operate and features user-friendly keys. Furthermore, the large liquid-crystal display provides excellent visibility, and the instrument's high speed and stability—intrinsic to a tuning fork design—help boost operational efficiency.

Before using the balance, please check that the following items have been included in the package.

Should you find any missing parts, please contact your local dealer or our marketing division at once.

(1) Main unit of balance

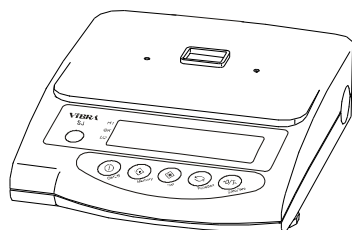

(2) Measurement pan
(one round or square pan)



Round pan
• SJ-220E~620E: ϕ 140mm

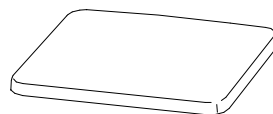

Square pan
• SJ-1200E: 170mm \times 140mm
• SJ-2200E~12KE: 180mm \times 160mm

(3) Pan base
(one small for the round-pan
balance; one large for the
square-pan balance)

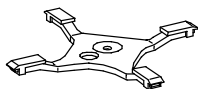

for Round pan

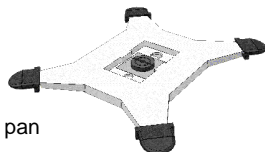

for Square pan

(4) AC adapter

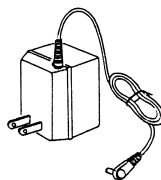

(5) Operation manual

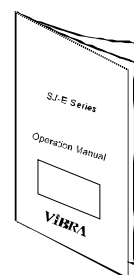

CONTENTS

1. Precautions on the Use	2	7. Measuring Percentage	20
2. Names of Component Parts	5	8. Limit Function.....	22
2.1 Main Unit.....	5	8.1 Limit Function Setup	22
2.2 LCD Indicators and Operating Keys ...	6	8.2 Setup of Limit Values by Actual Quantity Loads	24
3. Basic Operations	8	8.3 Setting up Limit Values by Inputting Values	25
3.1 Installation.....	8	9. Calibrating the Balance	27
3.2 Operation Check.....	9	10. Operating the Balance with the Battery	29
3.3 Operation for Tare Subtraction	10	11. Troubleshooting	30
4. Functions	12	12. Specifications	31
4.1 Setup and Checking of Functions...	12	12.1 Basic Specifications	31
4.2 Description of Functions	13	12.2 Common Specifications	31
4.3 Interface Section	14	12.3 Minimum Display by Unit of Measurement	32
5. Switching Function for Units of Measurement.....	15	13. Conversion Table of Units.....	34
5.1 Switching Units of Measurement	15		
5.2 Setup of Units of Measurement	15		
6. Counting Pieces	17		
6.1 Sampling.....	17		
6.2 Increasing the Counting Accuracy (Memory Update Method)	19		

1. Precautions on the Use

- This Section "Precautions Relating to Use" sets forth precautionary notes that the user should observe in order to prevent physical injury to the user and/or damage to property.
- The nature of problems that may result in the event of improper operation, and consequential effects on the quality and performance of the balance, are indicated under the two categories of "Caution" and "Recommended," and explained using symbols.



CAUTION

This symbol indicates a risk of injury or property damage if the balance is used improperly. Be sure to observe these notes to ensure safe use of the balance as the improper use may cause serious results.

RECOMMENDED

This term indicates steps that the user should take to ensure the quality and reliability of the balance.

Meanings of Symbols Each symbol is accompanied by an instruction.



Mandatory Symbol:

Indicates a "mandatory" action that should be executed without fail.



Check Level



Prohibitive Symbol:









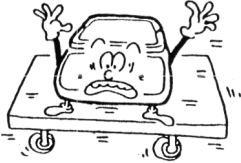

Indicates a "prohibited" action that must not be executed.



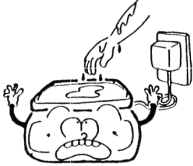

Do not Use

















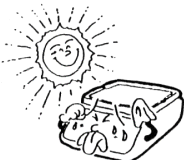

		<p>◆ Do not disassemble or modify the unit.</p> <ul style="list-style-type: none"> • Could cause malfunction or heat generation • Contact our Marketing Division or Technical Service Division.
		<p>◆ Only AC power (rated value) should be used.</p> <p>◆ Only use the dedicated AC adapter.</p> <ul style="list-style-type: none"> • Use of other types of power or adapters may result in heat generation or malfunction of the balance.
		<p>◆ Do not move the balance when a sample is loaded.</p> <ul style="list-style-type: none"> • The loaded sample may fall off the measurement pan and cause an injury.

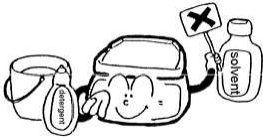
 Do Not Use		<p>◆ Do not place the balance on an unstable base or use the balance in a location where it may be subjected to shock.</p> <ul style="list-style-type: none"> • The loaded sample may fall off the measurement pan. • Accurate measurement may be rendered impossible.
 Do Not Drop		<p>◆ Do not lay the AC adapter cable on the surface of the passage.</p> <ul style="list-style-type: none"> • Somebody may trip on the cable, causing the balance to fall off, thereby causing injury and/or damage to the balance.
 Do not Handle with Wet Hands		<p>◆ Do not touch the AC adapter or balance with wet hands.</p> <ul style="list-style-type: none"> • Danger of electric shock
 Keep Dry		<p>◆ Do not use the balance in a location where it may be subjected to excess moisture.</p> <ul style="list-style-type: none"> • Electric shock or short-circuiting could occur. • The balance may be corroded, with resultant malfunction.
 Do Not Leave Afloat		<p>◆ Do not use the balance with its adjusters lifted.</p> <ul style="list-style-type: none"> • The balance will become unstable, preventing accurate measurement.
 Avoid Dust		<p>◆ Do not use the balance in a location where it may be subjected to excess dust.</p> <ul style="list-style-type: none"> • Risk of explosion or fire • Short-circuit or lack of continuity may occur, leading to a malfunction of the balance.

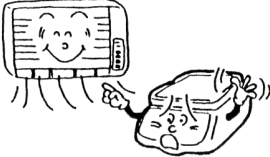
RECOMMENDED

 Calibrate Balance		<p>◆ Calibrate the balance after installation or relocation.</p> <ul style="list-style-type: none"> • Measurement values may contain errors, preventing accurate measurement from being conducted.
---	---	--

 Do Not Apply Force		<ul style="list-style-type: none"> ◆ Avoid applying excess force or impact to the balance. <ul style="list-style-type: none"> • Place the sample to be measured on the balance carefully to prevent breakage or malfunction.
 Do Not Use		<ul style="list-style-type: none"> ◆ Do not use the balance in a location where it may be subjected to abrupt changes in ambient temperature or humidity. <ul style="list-style-type: none"> • Accurate measurement may not be obtained. • Optimum operations occur when ambient temperatures range from 5°C to 35°C, and less than 80% relative humidity.
 Do Not Overload		<ul style="list-style-type: none"> ◆ Do not use the balance when [O - Err] (Overloaded) is displayed. <ul style="list-style-type: none"> • Take down the loaded sample immediately to prevent breakage or malfunction.
 Do Not Use		<ul style="list-style-type: none"> ◆ Do not use the balance in a location where it is subject to direct sunlight. <ul style="list-style-type: none"> • The indications would be illegible. • An internal temperature increase in the balance may lead to inaccurate measurement.
 Unplug Adapter		<ul style="list-style-type: none"> ◆ If the balance is to be unused for an extended period of time, unplug the adapter. <ul style="list-style-type: none"> • This conserves power and prevents deterioration.
 Do Not Use		<ul style="list-style-type: none"> ◆ Do not use volatile solvents for cleaning. <ul style="list-style-type: none"> • The body may be distorted. • To clean the unit of stains, use a piece of dry cloth or cloth soaked in a small quantity of neutral detergent.
 Do Not Use		<ul style="list-style-type: none"> ◆ Do not use the balance in a location where it may be subject to air from an air-conditioning unit. <ul style="list-style-type: none"> • Extreme changes in the ambient temperature may result in inaccurate measurements.
 Do Not Use		<ul style="list-style-type: none"> ◆ Do not use the balance on a soft floor. <ul style="list-style-type: none"> • When loaded with a sample, the balance may tip or move, preventing accurate measurements from being conducted.
 Check Level		<ul style="list-style-type: none"> ◆ Do not use the balance when it is tilted. ◆ An inclined balance is likely to produce errors, preventing accurate measurements from being conducted. Place the balance on a level surface.

2. Names of Component Parts

2.1 Main Unit

Round-pan types (SJ-220E, SJ-420E, SJ-620E)

Square-pan types (SJ-1200E, SJ-2200E, SJ-4200E, SJ-6200E, SJ-12KE)

Front View (round-pan type)

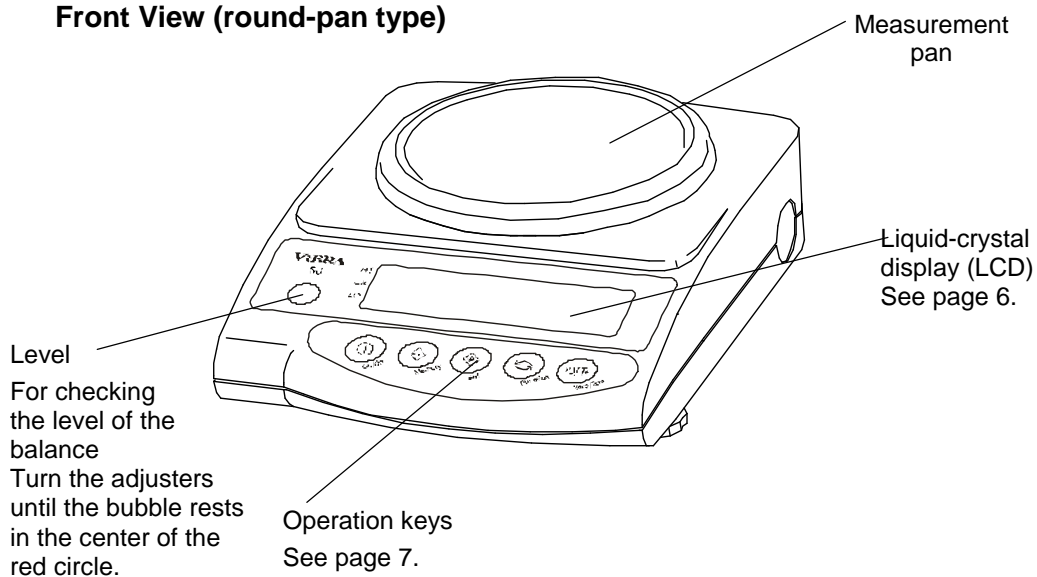

Rear view

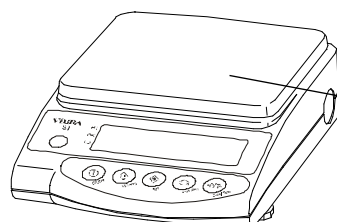
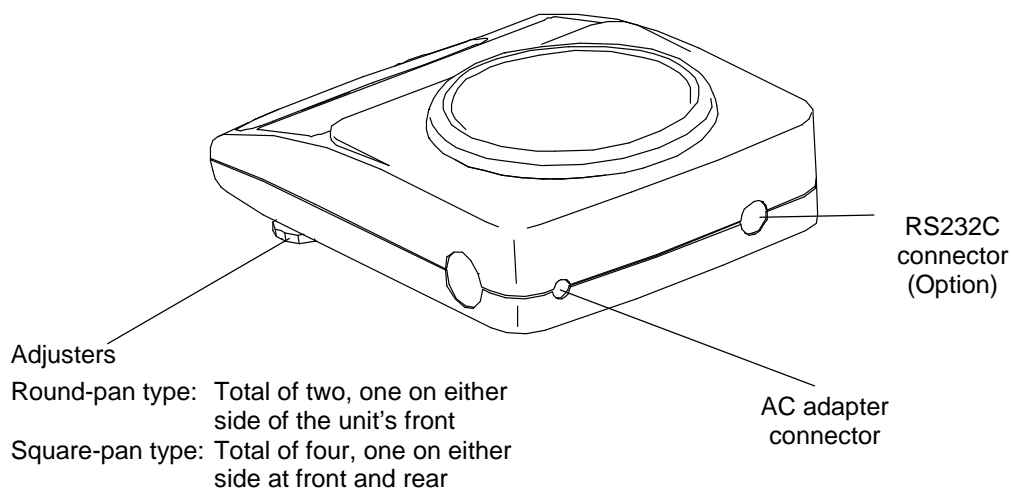

Square-pan type

- Measurement pan
- SJ-1200E:170mm × 140mm
 - SJ-2200E~SJ-12KE:180mm × 160mm



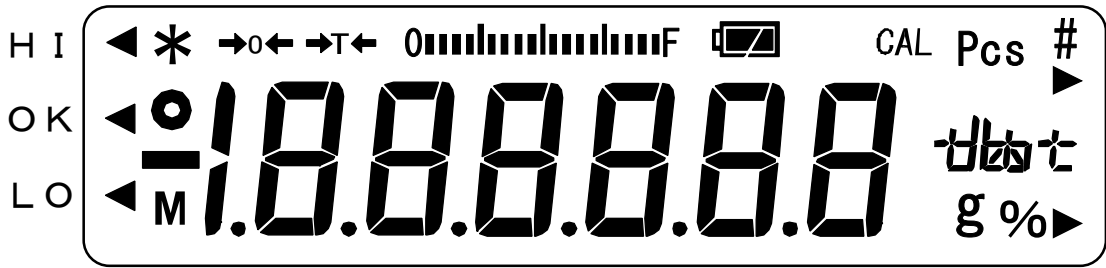

2.2 LCD Indicators and Operating Keys

2.2.1 Symbols Displayed



Display	Description
g	Grams
→0←	Zero point
→T←	Tare being subtracted
○	Indication of stable balance (If the light is off, the balance is unstable.)
*	Balance powered up (Lights up when the power is turned off) or data transmitted
Pcs	Counting mode
%	Percentage mode
◀	Indication of judgement result (HI/OK/LO) when the limit function is active.
mom	Momme
M	Display of set values from memory (If a value is flashing, it is being saved.)
CAL	Stays on and flashes while span adjustment is in progress.
	Bar graph
	[ct] (ct) carat
	[oz] (oz) ounce
	[lb] (lb) pound
	[oz t] (ozt) troy ounce
	[dwt] (dwt) penny weight
	[▶(Upper right)] grain
	[t!] (tl) tael (Hong Kong)
	[t! ▶ Upper right] (tl ▶ Upper right) tael (Singapore, Malaysia)
	[t! ▶ Lower right] (tl ▶ Lower right) tael (Taiwan)
[to] (to) tola	
	Lights up when the balance is battery-operated. The indication changes to when the battery capacity decreases and charging is required. (See "10. Operating the Balance on the Battery" on page 29.)

2.2.2 Names and Functions of Operating Keys

Operating Key	Function	
	On/off key	Key to turn on/off the unit power
	Memory key	[Brief press] initiates print or output. [Brief press] saves the settings of the number of pieces or percentages (%), or the limit value when using the limit function.
	Set key	[Brief press] starts setting the number of pieces or percentages (%). [Continuous press] starts setting the limit value when using the limit function.
	Function key	[Brief press] toggle-switches the units to be displayed in succession (g, Pcs, %, etc.). [Brief press] moves the flashing digit in the setup of a limit value when using the value input method. [Brief press] selects an item when setting the function. [Continuous press] invokes various functions. [Longer continuous press] invokes span adjustment.
	Zero/Tare key	[Brief press] resets the indication to zero when using zero-point setup or tare subtraction. [Brief press] selects a value with the value input method when using the limit function. [Brief press] selects a function when operating the balance in the function mode.

3. Basic Operations

3.1 Installation

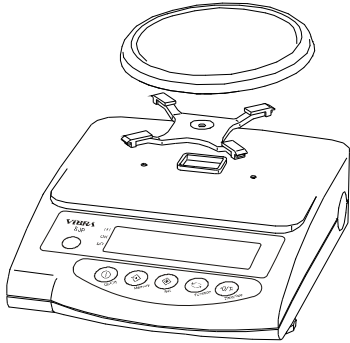
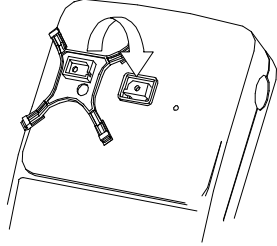
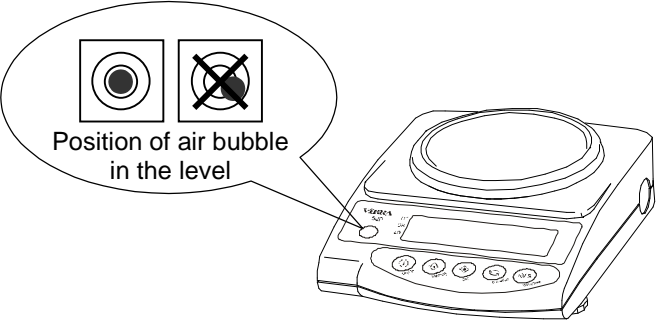
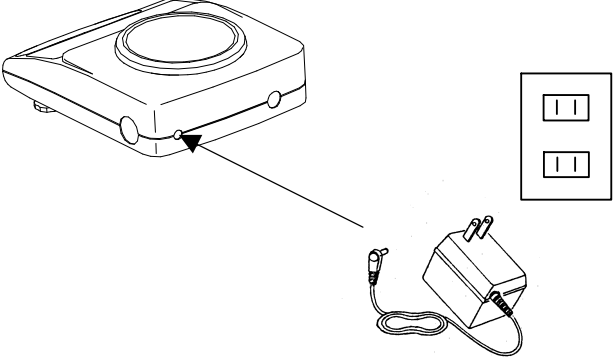
<p>1 Positioning the measurement pan</p> 	<p>First, mount the pan base on the main unit of the balance and place the measurement pan on top of it. Be sure to mount the pan base in the correct direction, as illustrated below.</p> 
<p>2 Securing the exact level of the balance</p>  <p>Position of air bubble in the level</p>	<p>Turn the adjusters until the bubble rests in the center of the red circle on the level.</p> <p>Round-pan type: total of two adjusters, one on either side at front</p> <p>Square-pan type: total of four adjusters, one on either side at front and rear</p> <p><Caution> Use caution when operating the adjusters on the square-pan type to prevent them from lifting up.</p>
<p>3 Connecting the AC adapter</p> 	<p>Connect the AC adapter to the balance, as illustrated at left.</p>

3.2 Operation Check

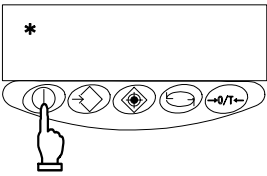
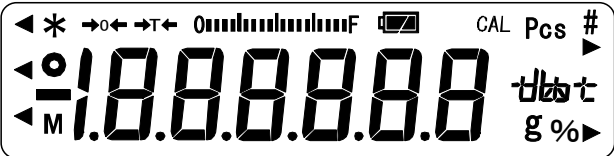
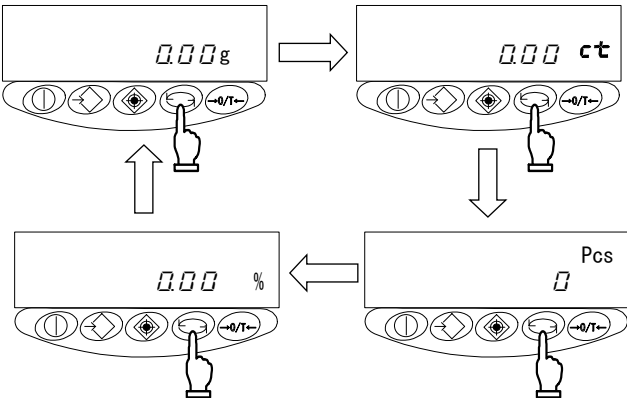
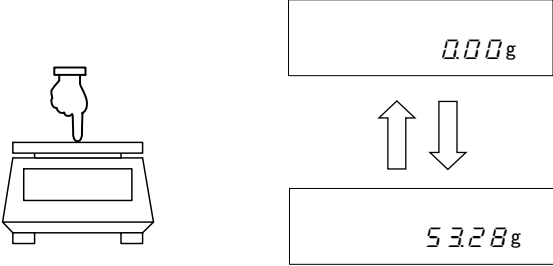
<p>1 Turning on the power</p> 	<p>When the balance has the AC adapter connected, it displays [*]. Pressing the On/Off key The display section lights up, and the balance is ready for operation.</p>
<p>2 Checking the display</p> 	<p>Check to see if the display has any missing indications or unlit parts. A few seconds after startup, the indication is reset to zero.</p>
<p>3 Switching the measurement mode</p> 	<p>Press the Function key. Each time the key is pressed, the unit of measurement changes, as indicated.</p> <p>※The balance is shipped from the factory with the following switching sequence: [g] → [ct] → [Pcs] → [%] → [g] → . . .</p>
<p>4 Verifying changes in the read-out indicator</p> 	<p>Press the measurement pan lightly and make sure that the read-out indicator changes. Also, ensure that the read-out indicator is reset to zero when you release your hand.</p>

3.3 Operation for Tare Subtraction

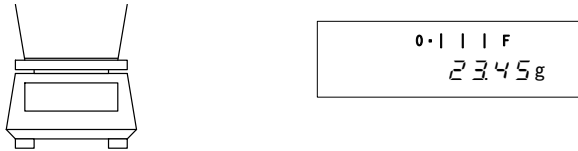
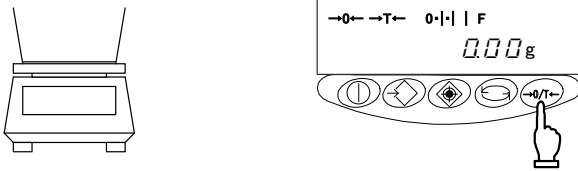
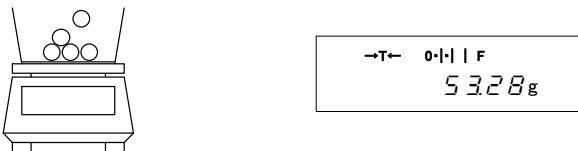
<p>1 Place the tare (container) on the balance.</p> 	<p>As you place the tare, the balance indicates its weight.</p>
<p>2 Reset read-out indication to zero.</p> 	<p>Press the Zero/Tare key. The tare is subtracted and the balance indicates zero.</p>
<p>3 Load the sample to be weighed.</p> 	<p>The balance will now indicate only the weight of the sample loaded in the tare.</p>

☆ Weighing only the weight of an added sample

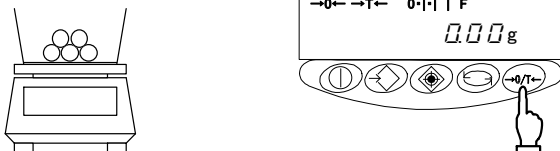
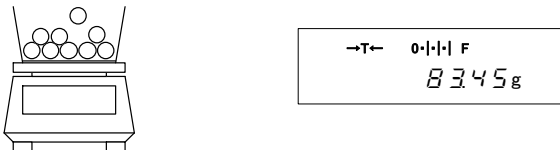
<p>4 Resetting the indication to zero</p> 	<p>Press the Zero/Tare key. The total weight of the sample loaded on the measurement pan is indicated as zero.</p>
<p>5 Adding samples to be measured</p> 	<p>The balance indicates only the weight of an added sample. When the weight (of a sample) currently loaded on the measurement pan is reset to zero with the Zero/Tare key, as mentioned above, only the weight of the sample will be measured.</p>

★ Key Points of the Procedure ★

The following applies equally to all the measurement modes for weight measurement, counting, and percentages.

- After the balance is switched off, there is still enough current to display [*]. This indicates that the AC adapter is connected to an electrical outlet, but that the balance is turned off. When the balance is switched on again, [*] will disappear.
 ※If the balance is running on batteries and the unit is switched off, the display does not display [*].

- The bar graph shows the current load status with respect to the capacity of the balance. The nearer the [F] mark draws, the smaller the measurable weight becomes.
 ※Even when the display currently indicates zero with the tare subtracted, the weight corresponding to the subtracted tare is indicated on the bar.

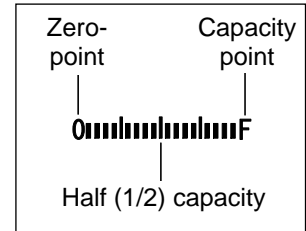

- When the balance remains stable, the stability indicator [O] remains on. If the balance becomes unstable, the stability indicator [O] will disappear. When a displayed value flickers or the stability mark flashes on and off, it is likely that the balance is being affected by wind or other vibrations. Use the windshield or vibration dampers to protect against such adverse effects.

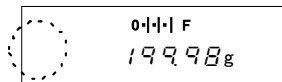

Unstable

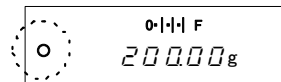

Stable

- When the read-out indicator is reset to zero or the tare is subtracted, the balance indicates zero this way: [→ 0 ←]. If the tare is subtracted, the indicator reads as follows: [→ T ←].

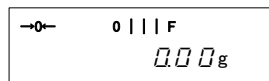

* If the indication deviates from the true zero point by 1/4 of a graduation or less, [→ 0 ←] disappears.

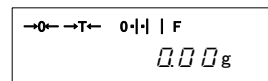

* If the tare is subtracted, the balance indicates zero, and [→ T ←] lights up.

- When the tare is subtracted, the measurable range is reduced.
 Measurable Range = Capacity - Tare Weight
- If [E r r] appears when a sample is loaded, the measurable range has been exceeded.
- In counting mode or percentage mode, if no sample is stored in memory the indicator will not change, even when the measurement pan is pressed.
- The measurement mode that is activated when the balance is switched on will be the one that was active when last switched off. For example, if the balance was switched off in counting mode, this counting mode will be reactivated the next time the balance is switched on.

4. Functions

4.1 Setup and Checking of Functions

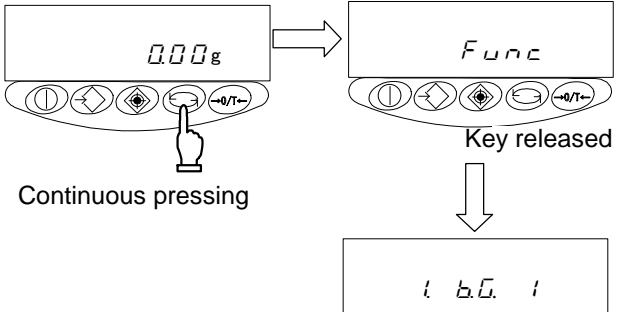
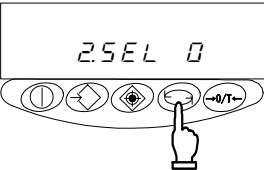
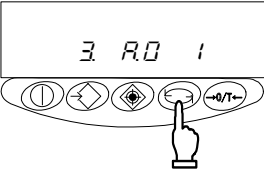
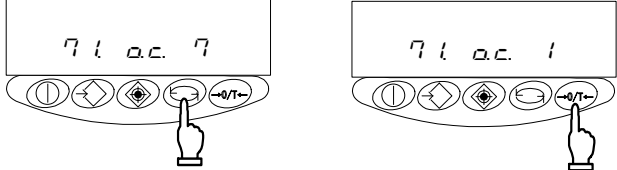
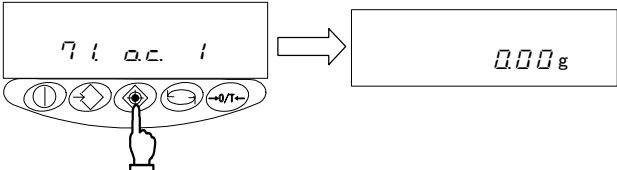
<p>1 Invoking the function</p>  <p>Continuous pressing</p> <p>Key released</p>	<p>Press and hold down the Function key until the indicator changes to "Func," then release the key.</p> <p>The function setup mode is activated, and the first item, [1 b.G. 1 (Bar graph) 1] appears. (See "4.2 Description of Functions" on page 13.)</p>
<p>2 Selecting the next item</p> 	<p>Press the Function key.</p> <p>The indication changes to the next item, [2.5EL 0 (Limit function)].</p>
<p>3 Selecting an item</p> 	<p>Pressing the Function key advances the function items at the rate of one item per press.</p>
<p>4 Changing the content of an item</p> 	<p>Select the item to be changed with the Function key.</p> <p>Each press of the Zero/Tare key changes the digit on the right end. Select the desired one.</p>
<p>5 Terminating the function selection</p> 	<p>Press the Set key.</p> <p>The balance terminates the function setup and returns to measurement mode.</p>

4.2 Description of Functions

Item		Set Value	Description		
Bar graph display		0	Disable		
		★1	Enable		
Limit function		★0	Disable		
		1	Enable		
Displayed only when limit function is activated	Judgement condition	★1	Always judge (judges even when the balance is unstable)		
		2	Judge only when the balance is stable (does not judge if the balance is unstable)		
	Judgement range	0	Ranges beyond +5 graduation is judged (ranges +5 graduation or below, including negative ranges, are not judged.)		
		★1	The entire range is judged (the entire range, including the negative, is judged).		
Number of points for judgement	1	One-point setup (judges between OK and LO)			
	★2	Upper-limit and lower-limit values are set up (judges among HI, OK and LO).			
Auto-zero (zero-tracking)		3	0 ★1	Disable Enable	This function automatically sets the zero point exactly to zero to prevent slight deviations.
Auto power-off		4	0 1	Disable (balance operates continuously) Enable (balance powers off in approximately three minutes)	This function is available only when the balance is battery-operated.
Response speed		0	Measurement by consecutive weighings.		
		1			
		2	Fast		
		★3	↓		
		4	Slow		
Stability parameters		1			
		★2	Wide (mild)		
		3	↓		
		4	Narrow (strict)		
Interface		0	Disable input/output		
		★1	Six-digit numeric format		
		2	Seven-digit numeric format		
Setup of units of measurement to be displayed Register selected measuring units with Function key.		★1	0	[g]	
		★2	14	[ct] (ct)	
			15	[oz] (oz)	
			16	[lb] (lb)	
			17	[oz t] (ozt)	
			18	[dwt] (dwt)	
			19	[▶ Lower right] (grain)*	

Items marked ☆ are the default factory settings. ☆1~☆5: default settings [8 15.u]~[8 5.5.u]

*Not available in SJ-12KE.

4.2 Description of Functions (cont.)

Setup of measurement units to be displayed*1	8 15.u	1A	[t/] (tl_Hong Kong)
		1B	[t/ ▶] (tl_Singapore, Malaysia)
Register measurement units by selecting [Function] key	8 55.u	1C	[t/ ▶] (tl_Taiwan)
		1D	[mom]
		1E	[to] (to)
		★3 20	[Pcs]
		★4 1F	[%]
		★5 00	Unit not set

★1~★5: default factory settings [8 15.u]~[8 55.u]

※1 [00] cannot be set at [8 15.u].

4.3 Interface Section

Displayed when [7 1F. □] is set to [1] or [2]

Item	Set Value	Description	
Output Control	7 1.o.c.	0	Stop output
		1	Output continuous at all times
		2	Output continuous if stable (stop output if unstable)
		3	Outputs once by pressing [Memory] key (irrespective of whether stable).
		4	Outputs once if stable. Outputs if the balance is stable when a sample is loaded after the preceding sample has been removed and the balance indicated zero, or less.
		5	Outputs once if stable, and stops output when unstable. Even if the sample is not replaced, the balance is output once when it stabilizes next time (including the zero indication).
		6	Outputs once if stable, and outputs continuously when unstable. Even if the sample is not replaced, output of the balance stops when it stabilizes after being output once.
Baud Rate	7 2.b.L.	★1	1200 bps
		2	2400 bps
		3	4800 bps
		4	9600 bps
Parity	7 3.P.R.	★0	None
		1	Odd
		2	Even

★ denotes a factory-setting

※ The data interval in continuous output mode is 0.1 to 1 second. (The interval varies depending on weighting conditions and other factors.)

5. Switching Function for Units of Measurement

Pressing the **[Function]** key allows the user to switch the unit of measurement to [g], [ct], [%], and so on. During setup, a maximum of five different units can be registered for use in function setup mode.

5.1 Switching Units of Measurement

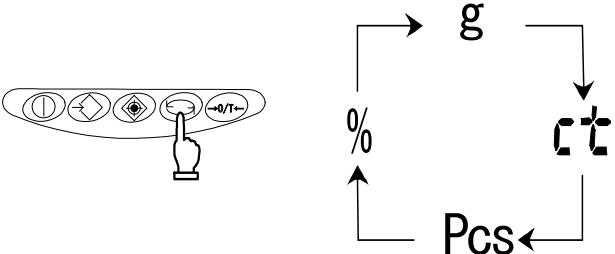
<p>Switching the units of measurement to be displayed</p> 	<p>Press the [Function] key. Each press advances through the units of measurement to be displayed.</p> <p>※The balance is shipped from the factory with the following default setup: [g] → [ct] → [Pcs] → [%] → [g] → ...</p>
---	--

5.2 Setup of Units of Measurement

When values [B 15.u.] to [B 55.u.] are entered prior to use, the desired unit of measurement to be displayed can be chosen simply by pressing the **[Function]** key. For more information on the units of measurement that can be set here, please refer to “4.2 Description of Functions” on page 13.

Example: To change the default factory settings to pound units, use [B 25.u.] in the factory settings.

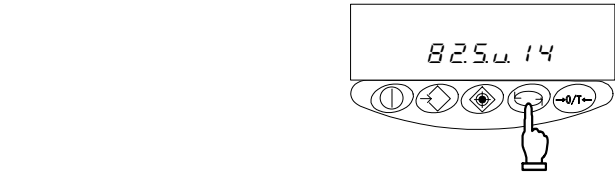
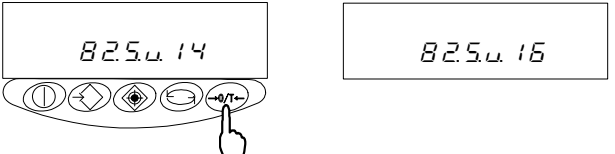
<p>1 Display the function item [B 25.u. 14]</p> 	<p>Press and hold down the [Function] key. Release the key as [F u n c] appears on the display. The function setup mode is now activated and the first item is displayed. Press the [Function] key several more times, until [B 25.u. 14] appears.</p>
<p>2 Setting the unit to a pound</p> 	<p>Press the [Zero/Tare] key several times to specify [B 25.u. 16].</p>

Example: To change the default factory settings to pound units use [82.5.u.] in the factory settings. (cont.)

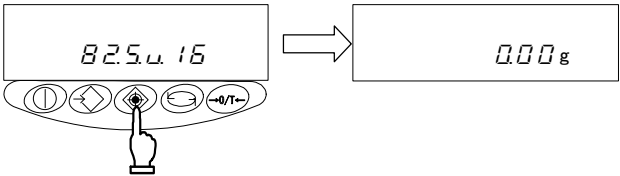
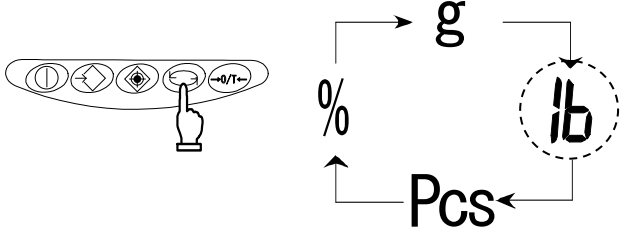
<p>3 Pressing the [Set] key to restore measurement mode.</p> 	<p>Pressing the [Set] key will reset the measurement mode</p>
<p>4 Pressing the [Function] key to change the units of measurement</p> 	<p>Press the [Function] key. Each press of the key changes the units of measurement to be displayed, as follows: [g] → [lb] → [Pcs] → [%] → [g] → ...</p>

★ Key Points of the Procedure ★

1. When set values are entered in the function items [8 1.5.u.] to [8 5.5.u.] prior to use, the desired unit of measurement to be displayed can be selected simply pressing the [Function] key. For more information on the units of measurement that can be set, please refer to “4.2 Description of Functions,” on page 13.
2. The units are displayed in the same sequence as the settings made from [8 1.5.u.] to [8 5.5.u.].
3. If [00] is set, no unit of measurement will be displayed, even when units of measurement are set in subsequent items.
4. [00] cannot be set in [8 1.5.u.].
5. If the same unit of measurement is set multiple times, the second time (and all subsequent times) the unit(s) occurs, it will be ignored when the display switches.

6. Counting Pieces

To implement piece-counting, the specified samples are loaded on the balance, and their average unit weight (hereinafter, simply the “unit weight”) is entered and saved. The procedure for saving unit weights is called sampling.

The counting procedure consists of loading articles that have already been sampled on to the balance. The number of pieces is then calculated by dividing the total weight of the loaded articles by the unit weight saved in memory. Piece counting cannot be implemented unless sampling has already taken place.

Sampling

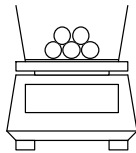

$$\frac{\text{Weight}}{\text{Number of samples}} = \frac{10 \text{ g}}{10 \text{ pieces}} = 1 \text{ g}$$

= Sample unit weight

Counting Pieces

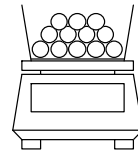

$$\frac{\text{Total weight}}{\text{Sample unit weight}} = \frac{500 \text{ g}}{1 \text{ g}} = 500 \text{ pcs.}$$

= Measured number of samples

※If samples to be counted deviate widely in weight, or a higher measure of accuracy is desired, it is recommended that users use the “Raising the Counting Accuracy” method. This procedure results in greater precision by increasing the number of samples used in the sampling operation.

6.1 Sampling

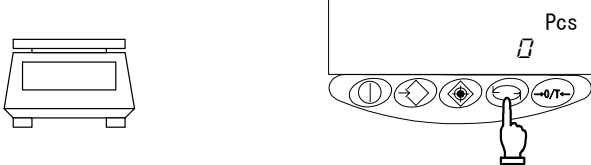
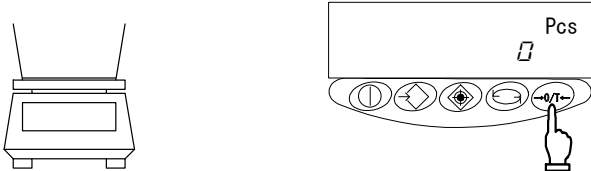
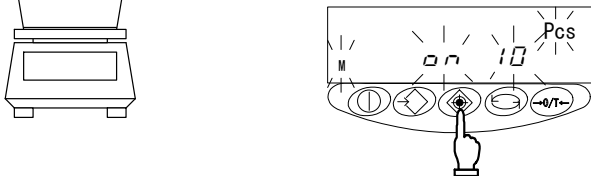
<p>1 Activating the counting mode</p> 	<p>Press the Function key to display [Pcs].</p>
<p>2 Resetting the indication to zero</p> 	<p>Place the tare and press the Zero/Tare key. The tare is subtracted and the balance now indicates zero.</p>
<p>3 Starting the sampling</p> 	<p>Press the Set key. The display flashes a number, such as [0 n 10]. This means that ten samples are to be loaded. The sampling number that was used in the previous sampling will be displayed here.</p>

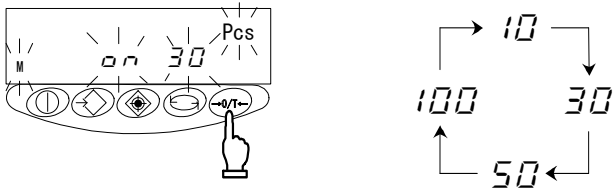
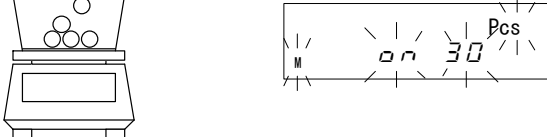
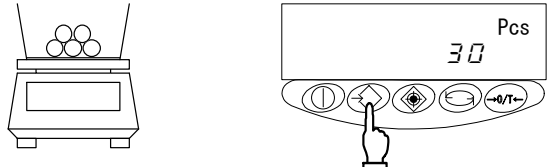
<p>4 Changing the sampling number, if necessary.</p> <p>How to change the value</p> 	<p>If samples to be counted widely deviate in weight, or a higher measure of accuracy is desired, it is recommended that users change the sampling number to a larger value.</p> <p>Press the Zero/Tare key.</p> <p>Each press of the key changes the value on the right end. Select the desired value.</p> <p>If the sampling number need not be changed, go on to the next step.</p>
<p>5 Loading samples</p> 	<p>Load the number of samples displayed.</p> <p>Count the samples precisely and load them in the center of the measurement pan.</p>
<p>6 Saving the unit weight of samples</p> 	<p>Press the Memory key.</p> <p>The balance saves the unit weight and reverts to measurement mode.</p>

★ Key Points of the Procedure ★

- While the samples are being saved, the value indication disappears and only [M] flashes to indicate that memory saving is underway. If the balance is affected by wind or other vibrations during this process, the saving time may be prolonged.
- If [$L - E r r$] appears, it indicates one of the following states:
 - The weight of one sample (measurable unit weight) is insufficient.
For the range of unit weights that can be measured and saved, please refer to “12. Specifications,” on page 31.
 - In the sampling of Operation Step 3, press the **Set** key with the samples loaded on the balance.

※ If [$L - E r r$] appears, the sampling is interrupted and the data in progress is not saved.
- The operation for increasing counting accuracy is referred to as the Memory Update Method. This procedure updates the memory with a unit weight that represents a more precise average by gradually increasing the sampling number.
This operation improves counting accuracy and is recommended for the following cases;
 - When the samples to be counted deviate widely in weight or the number of samples displayed deviates.
 - When greater accuracy is desired.
- If [$R d d$] appears in Memory Update Method, it indicates that a counting error is likely due to the small number of the samples loaded on the balance. [\blacktriangleleft] will light up at the judgment indication “LO.” As the memory update continues, counting accuracy improves and the above indication disappears.
- If you change the sampling number, subsequent sampling will start from the new sampling number.

6.2 Increasing the Counting Accuracy (Memory Update Method)

※ This procedure is the same as the sampling procedure described on the previous page up, to the point at which the sampling number is changed.

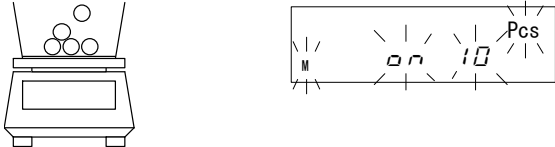
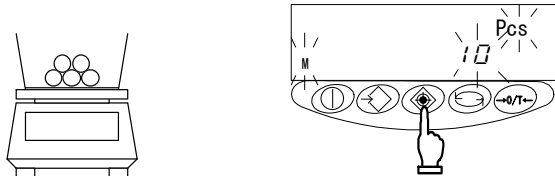
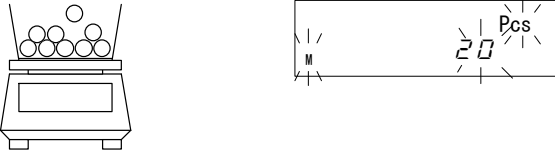
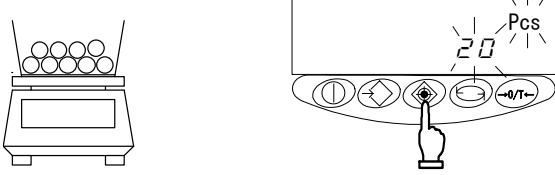
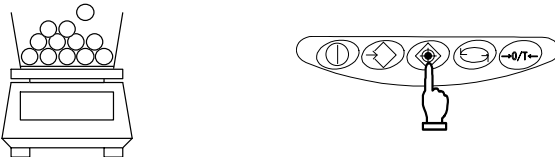
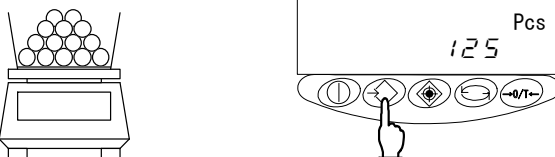
<p>1 Loading samples</p> 	<p>Load the number of samples displayed. Count the samples precisely and load them on to the center of the measurement pan.</p>
<p>2 Saving the samples</p> 	<p>Press the Set key. The unit weight of the samples is saved, and the display changes to a flashing value. This flashing value denotes that the Memory Update Method is currently active.</p>
<p>3 Adding samples</p> 	<p>Add approximately an equal number of samples as the number currently displayed. Add them gradually, in groups of approximately the same number, until the number of samples is approximately double. The additional samples need not be counted.</p>
<p>4 Saving the samples</p> 	<p>Press the Set key. After the unit weight of the samples has been saved, the display begins to flash, indicating that the Memory Update Method is still running.</p>
<p>5 Repeating the addition and saving of samples</p> 	<p>Repeat steps 3 and 4. The eventual total number of samples to be saved should be approximately 1/5 to 1/2 of the number of samples to be measured.</p>
<p>6 Terminating the sampling</p> 	<p>Press the Memory key. The balance saves the unit weight and returns you to measurement mode.</p>

7. Measuring Percentage

The percentage measurement function operates by weighing an actual sample, selected as the reference, and saving its weight as the reference value and indexing it as 100%. When a measurement sample loaded on the balance is lighter or heavier than the reference, its weight is indicated as a percentage (%) value relative to the reference weight.

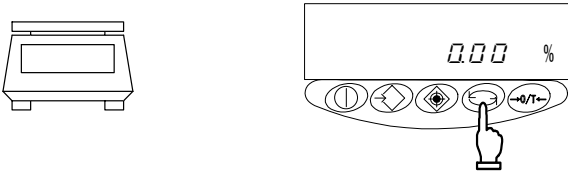
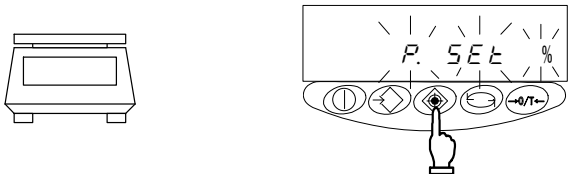
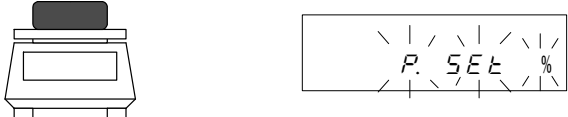
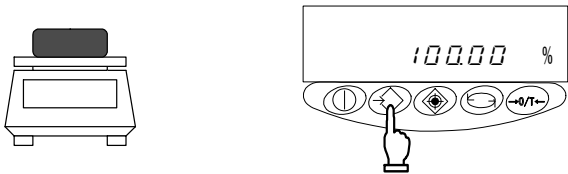
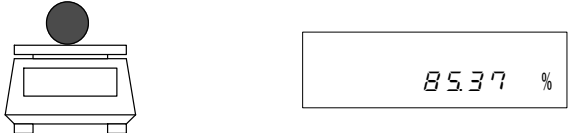
<p>1 Activating the percentage mode</p> 	<p>Press the Function key to display [%].</p>
<p>2 Setting the reference value</p> 	<p>Press the Set key. The display begins flashing [P. S E t]. The balance is now ready for reference value setup.</p>
<p>3 Loading the sample</p> 	<p>Load the reference sample.</p>
<p>4 Saving the reference value</p> 	<p>Press the Memory key. The balance indexes the weight value of the reference sample as 100% and returns you to measurement mode.</p>
<p>5 Loading a sample to be measured</p> 	<p>The balance now indicates the weight of the loaded sample as a percentage (%) value relative to the reference value.</p>

☆ Key Points of the Procedure ☆

1. While samples are being saved, the value indication disappears temporarily, and only the [M] mark flashes. If the balance is affected by wind or other vibrations during this process, the saving time may be prolonged.
2. If [$L - E r r$] appears briefly, it indicates one of the following states:
 - (1) The weight of the reference sample is insufficient.
For the limit weight that can be saved (% limit weight), please refer to “12. Specifications,” on page 31.
 - (2) While setting up the reference value in Step 2, the Set key has been pressed while the samples were loaded on the balance.

※If [$L - E r r$] appears, sampling has been interrupted and the sample value being processed will not be saved.
3. The minimum intervals between percentages in the unit switch from 1%, to 0.1%, to 0.01%, depending on the reference weight from the sampling.

8. Limit Function

The limit function judges measurements according to a limit value saved in the balance.

The function shows the judgement result by displaying the [◀] mark as either HI (excessive), OK (appropriate), or LO (insufficient). This function is very useful when discriminating between conforming and nonconforming articles. It is also useful when measuring a given constant quantity consecutively, in conjunction with a range of reference weights defined by upper- and lower-limit values.

This function can be used in weight mode, counting mode, or percentage mode.

Limit value input methods

Either of the following two methods can be used in the different modes:

- (1) Actual quantity setup method An actual sample is loaded on the balance and its weight saved as the limit value.
- (2) Numeric value setup method The limit value is entered with a key stroke.

※The limit values entered are held in memory, even when the balance is powered down.

※The respective limit values for weight mode, counting mode, and percentage mode are set up independently.

Indication of judgement result

The [◀] mark lights up as either HI, OK, or LO on the left side of the display, indicating the result of judgement.

Judgement Results	Upper/lower-limit setting	One-point setting
HI (excessive)	Upper-limit value < measurement value	No indication
OK (appropriate)	Upper-limit value ≥ measurement value value ≥ lower-limit value	Limit value ≤ measurement value
LO (insufficient)	Lower-limit value > Measurement value	Limit value > Measurement value

8.1 Limit Function Setup

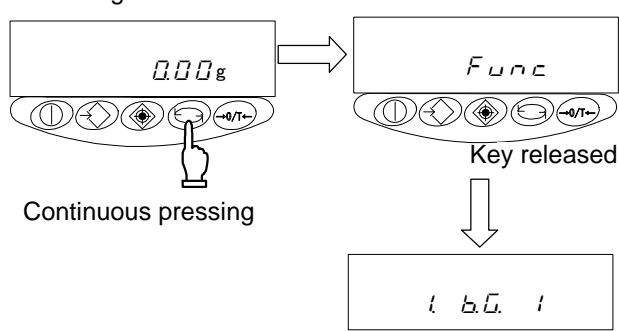
<p>1 Invoking the function</p> 	<p>Press and hold down the Function key. Release the key when [Func] is displayed. The display changes to the function setup and the first item is displayed.</p>
--	--

8.1 Limit Function Setup (cont.)

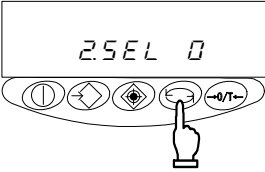
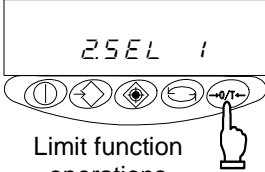
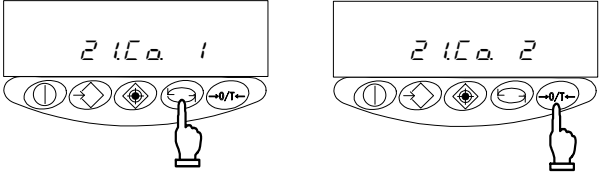
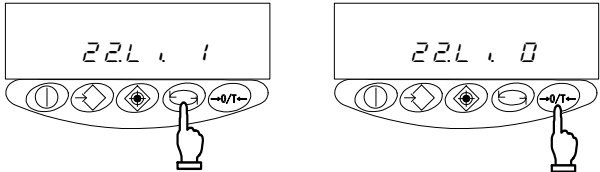
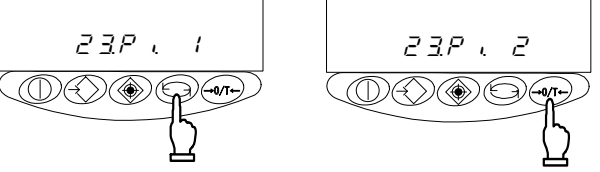
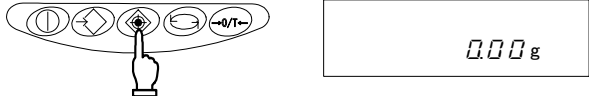
<p>2 Selecting a function item</p> 	<p>Press the Function key. The display changes to the next item [Limit Function].</p>
<p>3 Setting the limit function</p>  <p>Limit function operations</p>	<p>Press the Zero/Tare key to set the value on the rightmost side to [1].</p>
<p>4 Setting the judgement condition</p>  <p>Judged at all times Judged when stable</p>	<p>Press the Function key. The display changes to [Judgement Condition]. Press the Zero/Tare key to select the desired condition.</p>
<p>5 Setting the judgement range</p>  <p>Judge entire range Judge beyond +5</p>	<p>Press the Function key. The display changes to [Judgement Range]. Press the Zero/Tare key to select the desired choice.</p>
<p>6 Setting the number of judgement points</p>  <p>One point set Upper/lower limits set</p>	<p>Press the Function key. The display changes to [Judgement Points]. Press the Zero/Tare key to select the desired choice.</p>
<p>7 Terminating the function setup</p> 	<p>Press the Set key. The balance terminates the function setup and returns you to measurement mode.</p>

8.2 Setup of Limit Values by Actual Quantity Loads

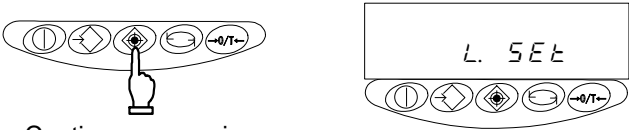
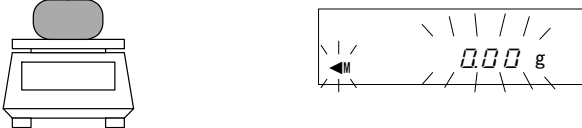
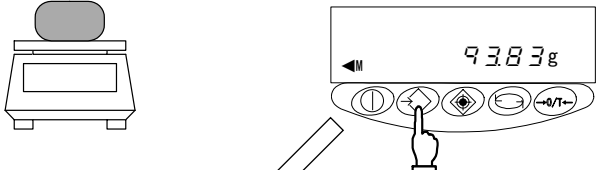
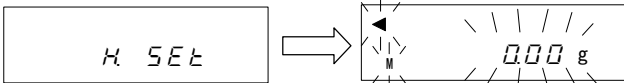
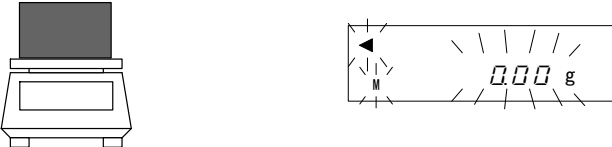
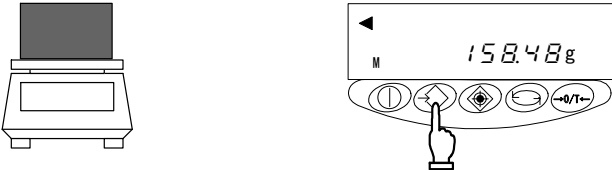
<p>1 Starting the limit function</p>  <p>Continuous pressing</p> <p>Key released</p>	<p>Press and hold down the Set key. Release the key when [L. SEt] is displayed. The currently set lower-limit value flashes.</p>
<p>2 Loading the sample for the lower-limit value</p> 	<p>Load the sample of the lower-limit value on the measurement pan.</p>
<p>3 Saving the lower-limit value</p> 	<p>Press the Memory key. After the lower-limit value has been saved, the balance displays it briefly and proceeds to the following setup. ※If One-point setup was chosen, the setup is complete.</p>
<p>4 The upper-limit value setup</p> 	<p>The display now changes to [H. SEt], indicating that the upper-limit value can be set. The currently set upper-limit value flashes.</p>
<p>5 Loading the sample of the upper-limit value</p> 	<p>Load the sample of the upper-limit value on the measurement pan.</p>
<p>6 Saving the upper-limit value</p> 	<p>Press the Memory key. After saving the upper-limit value, the balance displays it briefly and terminates the setup.</p>

8.3 Setting up Limit Values by Inputting Values

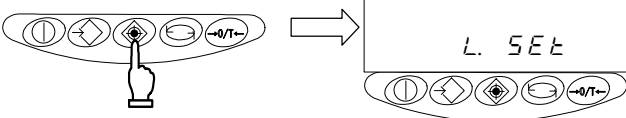
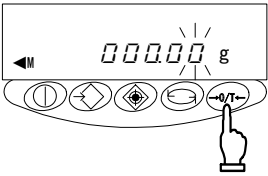
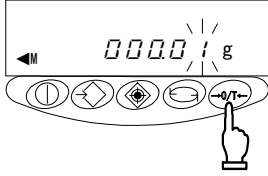
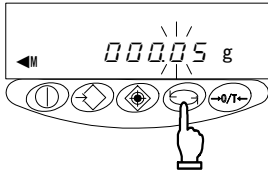
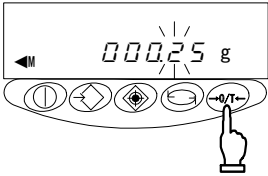
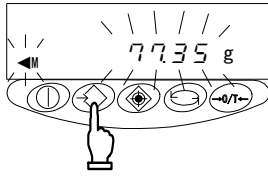
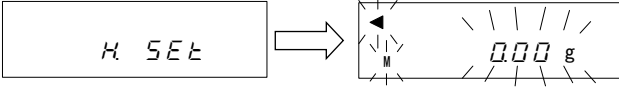
<p>1 Starting the limit function</p>  <p>Continuous pressing</p> <p>Key released</p>	<p>Press and hold down the Set key. Release the key when [L. SEt] is displayed. The currently set lower-limit value flashes.</p>
<p>2 Opening the value input screen</p> 	<p>Press the Zero/Tare key. All the digits are displayed, with the one on the right end flashing. This flashing digit is the one that can be changed.</p>
<p>3 Entering a value</p> 	<p>Press the Zero/Tare key again. Pressing the key repeatedly changes the flashing value until the desired number is entered.</p>
<p>4 Selecting a digit</p> 	<p>Press the Function key. The flashing moves to the digit on the immediate left. Each time the key is pressed, the flashing digit moves one position left. When the leftmost digit is selected, the flashing advances to the rightmost digit position.</p>
<p>5 Repeat Steps 3 and 4</p> 	<p>Enter the lower-limit value by selecting a value with the Zero/Tare key and moving the digits with the Function key, as needed.</p>
<p>6 Saving the lower-limit value</p> 	<p>Press the Memory key. After saving the lower-limit value, the balance displays it briefly and proceeds to the next setup. ※If one-point setup was chosen, the setup is complete.</p>
<p>7 Setting up the upper-limit value</p> 	<p>The display changes to [H. SEt], indicating that the upper-limit value can be set. If there is an upper-limit value already set, that value will flash.</p>

8.3 Setting up Limit Values by Inputting Values (cont.)

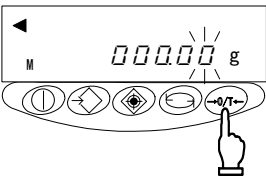
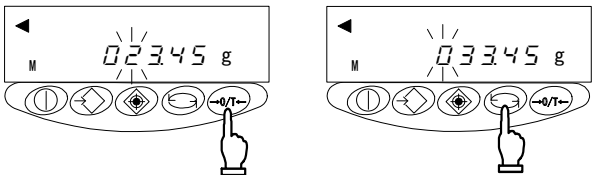
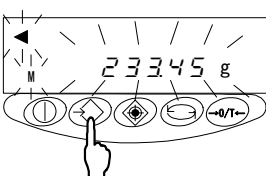
<p>8 Opening the value input screen</p> 	<p>Press the Zero/Tare key. Follow the same procedure as in “Step 2.”</p>
<p>9 Setting the upper-limit value</p> 	<p>Follow the same procedure as described for the lower-limit value and enter the upper-limit value.</p>
<p>10 Saving the upper-limit value</p> 	<p>Press the Memory key. After saving the upper-limit value, the balance displays it briefly and terminates setup.</p>

★ Key Points of the Procedure ★

- The limit values you have set can be checked each time you press the **Set** key. The balance displays the lower-limit value after showing [L. S E t], and the upper-limit value after showing [H. S E t].

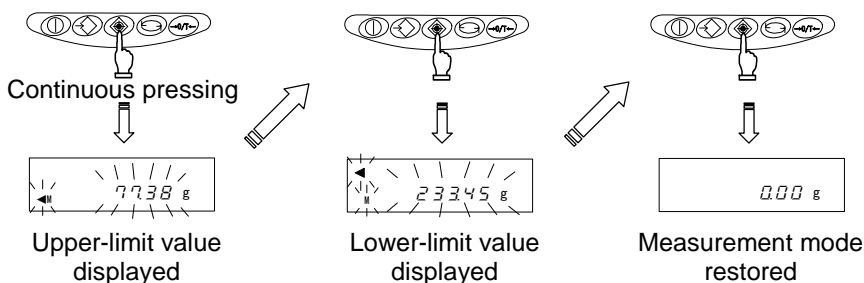



- If you make a mistake, press the **Function** key during the setup of actual quantities or the **Set** key during the setup of values.
- If you press the **Memory** key while a value is flashing, an actual quantity will be set based on the weight currently loaded on the balance. Pressing the **Zero/Tare** key at this time displays the value input screen.
- If the [M] mark lights up for all three judgement indicators, HI, OK, and LO, the lower-limit value set exceeds the upper-limit value. Check the values, since mistakes can occur with entries, as in cases when the upper-limit value is specified with a negative sign.
- When the [M] mark is flashing on the value input screen, the sign on the left end can be changed. Press the **Zero/Tare** key to switch between the positive and negative signs.

9. Calibrating the Balance

Since electronic balances are affected by gravity gravitational acceleration, they produce different values in various locations. Therefore, before use, balances must be calibrated at the location where they are installed. Calibration is also required after long periods without use, or if a balance begins to produce inaccurate values.

Calibration of a balance, or “span adjustment,” is required to produce accurate measurements.

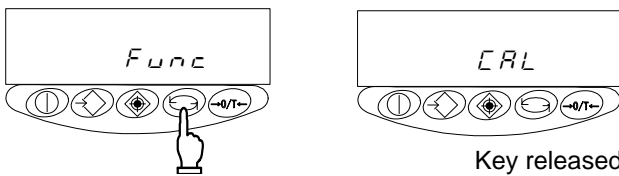
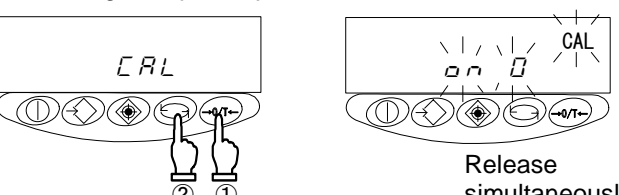
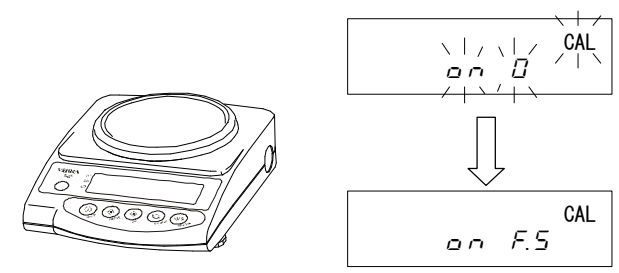
※ Span adjustment should be performed with the balance installed perfectly level and without any load on the measurement pan.

<p>1 Activating the span adjustment function</p>  <p>Pressed continuously</p> <p>Key released</p>	<p>Press and hold down the Function key. Release the key when the display changes from [Func] to [CAL].</p>
<p>2 Starting the span adjustment</p>  <p>Release simultaneously.</p> <p>Press the Function key while holding down the Zero/Tare key.</p>	<p>Press the Function key while holding down the Zero/Tare key, then release both keys simultaneously. The display flashes [0.0], indicating that zero-point calibration is underway.</p>
<p>3 Zero calibration</p>  	<p>Zero-point calibration is finished when the display changes to [0.0 F.S]. Proceed to the calibration of the capacity point.</p>

Calibrating the Balance (cont.)

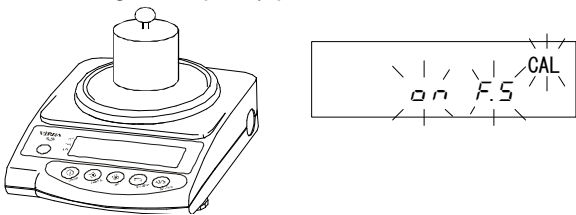
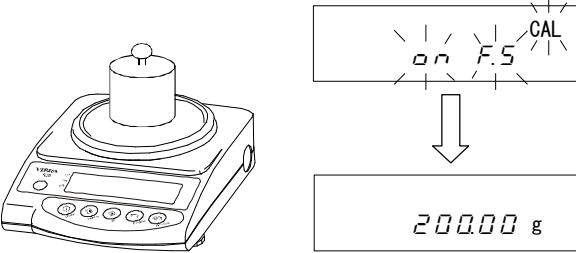
<p>4 Calibrating the capacity point</p> 	<p>Load the calibration weight in the center of the balance.</p> <p>The display flashes, indicating that capacity point calibration is in progress.</p>
<p>5 Terminating the span adjustment</p> 	<p>When the calibration of the capacity point is finished, the original measurement mode is restored.</p>

★ Key Points of the Procedure ★

- Pressing the **Function** key in Step 2 interrupts the span adjustment and returns you to the original measurement mode.
- The calibration weight used for span adjustment should be heavier than half the capacity of the balance.
To implement a calibration as precisely as possible, use a weight close to the capacity of the balance.
※ Calibration weights can be ordered from Shinko. For ordering information, please contact Shinko.
- If problems arise during span adjustments, one or more of the following error messages will appear:
 - [\square - E r r]: The calibration weight exceeds the capacity of the balance.
 - [\square - E r r]: The calibration weight is less than half the capacity of the balance.
 - [\square - E r r]: The difference between before and after calibration values is too large (1.0% or more).

※If error messages are displayed, calibration cannot take place.

Check the weight and re-calibrate. If the same error continues after repeated calibrations using the correct weight, please contact our Marketing Division or Technical Service Division.



10. Operating the Balance with the Battery

This function can be used only when the balance is battery-operated.

10.1 Specifications



- Built-in nickel-cadmium battery
- Charging time: Approximately 12 hours
- Drive time: Approximately 32 continuous hours
- Number of charge/discharge cycles: 300 or more

10.2 Charging Method

※While the balance is battery-operated,  stays on. The indicator flashes  (charging required) when battery capacity decreases. If the balance flashes , charge the battery by following these steps:

- (1) Connect the dedicated AC adapter to the balance.
- (2) Turn the balance off.
- (3) Charging takes approximately 12 hours, with power switched off. Charging the battery longer than 12 hours decreases battery life.

10.3 User Precautions

1. Once charging is complete, use the balance without the AC adapter to avoid over-charging. This can occur since the balance continues to charge the battery with a weak current when the power is switched on. Overcharging will also decrease battery life.
2. When the balance is used for the first time after purchase, the operating time may be shorter than when using a fully charged battery. This is due to natural discharge of the battery. Although the balance can be used while  is flashing, it should be recharged as soon as possible.
3. When the battery displays no indication, or an indication disappears quickly after the balance is switched on, battery capacity is low. In these cases, either charge the battery immediately or plug in the AC adapter.
4. Charging the battery while  is displayed reduces battery life.



Cautions To operate the balance safely, observe the following (failure to do so could result in malfunctions, breakage, burst batteries, or fire):

1. Do not disassemble or modify the battery. Do not reverse the balance connection or short-circuit the positive and negative polarities of the balance.
2. Use only the supplied AC adaptor.
3. Do not incinerate used batteries. Dispose as hazardous material only.

11. Troubleshooting

※ The numbers in () indicate reference pages

Symptom	Cause	Possible remediation
There is no indication on the display.	<ul style="list-style-type: none"> The AC adapter is not connected. 	→ Check that the AC adapter is connected (8).
The display is unstable. [M] remains flashing without changing.	<ul style="list-style-type: none"> The balance is subject to air currents or vibration. The balance is situated on an unstable surface. An object is contacting the sample being measured, the measuring pan, or the tare. 	→ Check Precautions on Use (2–4).
Weight indication contains an error.	<ul style="list-style-type: none"> An error was made in the tare subtraction procedure. The adjusters remain lifted, resulting in an incorrect level. The indication values are inconsistent after long hours of use, or because the balance has been moved to a new location. 	→ Review the tare subtraction (10). → Check the level (8). → Execute span adjustment on the balance (27).
The limit function does not work.	<ul style="list-style-type: none"> The limit function is not selected. The limit value has been erroneously entered. 	→ Check the operation of the limit function (22 on).
[H d d] appears ([◀] and a value flash at [LO].)	<ul style="list-style-type: none"> Likely to produce errors in the counting mode because the sample weight is insufficient. 	→ Execute the Memory Update Method (19).
[O - E r r] appears before the capacity is reached.	<ul style="list-style-type: none"> Gross weight exceeded the capacity of the balance (weight range = container + weight of sample). A section of the mechanism is damaged. 	→ Check the total weight. → Execute tare subtraction again. → Contact our Technical Service Division or your local dealer.
[U - E r r] is displayed.	<ul style="list-style-type: none"> A foreign object is caught between the measuring pan (pan base) and the balance. A section of the mechanism is damaged. 	→ Remove the measurement pan and examine the surface beneath it.
[b - E r r] is displayed. [d - E r r] is displayed.	<ul style="list-style-type: none"> The balance is exposed to static electricity or noise. The electrical system of the balance is malfunctioning. 	→ Contact our Technical Service Division or your local dealer.
During span adjustment [O - E r r] is displayed. [i - E r r] is displayed. [c - E r r] is displayed.	<ul style="list-style-type: none"> A weight heavier than the capacity was used. The reference weight is less than 50% of the capacity. Calibration produced an error of 1.0% or more. 	→ Check that the span adjustment procedure was performed correctly (27).
During battery installation: The indication disappears. [◻] flashes. No indication is produced.	<ul style="list-style-type: none"> The automatic power-off function was activated. The battery capacity is low. 	→ Switch on the power again. Deactivate the Automatic power-off function, if necessary (13). → Recharge the battery (29). → Operate the balance with the AC adapter.

12. Specifications

12.1 Basic Specifications

Model	SJ-220E	SJ-420E	SJ-620E	SJ-1200E
Capacity [g]	220	420	620	1200
Readability [g]	0.01	0.01	0.01	0.1
Measurable unit weight in counting mode [g]	0.01	0.01	0.01	0.1
Minimum weight in percentage mode [g]	1	1	1	10
Weight measuring method	Tuning fork vibration method			
Calibration method	With external calibration weight			
Pan Size [mm]	φ140			170x140

Model	SJ-2200E	SJ-4200E	SJ-6200E	SJ-12KE
Capacity [g]	2200	4200	6200	12000
Readability [g]	0.1	0.1	0.1	1
Measurable unit weight in counting mode [g]	0.1	0.1	0.1	1
Minimum weight in percentage mode [g]	10	10	10	100
Weight measuring method	Tuning fork vibration method			
Calibration method	With external calibration weight			
Pan Size [mm]	180x160			

12.2 Common Specifications

- (1) Tare subtraction range..... Total capacity
- (2) Liquid-crystal display (LCD)..... Seven segments (two segments in leading part) ,
Maximum digits indication: seven digits,
Segment height: 16.5 mm.
- (3) Measuring function Weight mode, counting mode, and percentage mode
- (4) Overload indication [$\bar{\square}$ - \bar{E} r r] is displayed if weight capacity + 9 intervals are exceeded.
- (5) Compatible printer CSP-160
- (6) Operating temperature and humidity ranges .. 5°C to 35°C, 80%rh or less
- (7) AC adapter..... Dedicated AC adapter: 100-240V AC / 9-12V DC
- (8) Options RS232C Output
Rechargeable battery operation

12.3 Minimum Display by Unit of Measurement

Model Unit_of measurement	SJ- 220E	SJ- 420E	SJ- 620E	SJ- 1200E
g	220 0.01	420 0.01	620 0.01	1200 0.1
ct (ct)	1100 0.05	2100 0.05	3100 0.05	6000 0.5
oz (oz)	7.7 0.0005	14 0.0005	21 0.0005	42 0.005
lb (lb)	0.48 0.00005	0.92 0.00005	1.3 0.00005	2.6 0.0005
oz t (ozt)	7 0.0005	13 0.0005	19 0.0005	38 0.005
dwt (dwt)	140 0.01	270 0.01	390 0.01	770 0.1
▶ (grain)	3300 0.2	6400 0.2	9500 0.2	18000 2
tl (Hong Kong)	5.8 0.0005	11 0.0005	16 0.0005	32 0.005
tl (Singapore, Malaysia)	5.8 0.0005	11 0.0005	16 0.0005	31 0.005
tl (Taiwan)	5.8 0.0005	11 0.0005	16 0.0005	32 0.005
mom (momme)	58 0.005	110 0.005	160 0.005	320 0.05
to (to)	18 0.001	36 0.001	53 0.001	100 0.01

※The view of the table

Upper cell : Capacity
Lower cell : Readability

Model Unit_of measurmant	SJ- 2200E	SJ- 4200E	SJ- 6200E	SJ- 12KE
g	2200 0.1	4200 0.1	6200 0.1	12000 1
ct (ct)	11000 0.5	21000 0.5	31000 0.5	60000 5
oz (oz)	77 0.005	140 0.005	210 0.005	420 0.05
lb (lb)	4.8 0.0005	9.2 0.0005	13 0.0005	26 0.005
oz t (ozt)	70 0.005	130 0.005	190 0.005	380 0.05
dwt (dwt)	1400 0.1	2700 0.1	3900 0.1	7700 1
▶ (grain)	33000 2	64000 2	95000 2	
ti (Hong Kong)	58 0.005	110 0.005	160 0.005	320 0.05
ti (Singapore, Malaysia)	58 0.005	110 0.005	160 0.005	310 0.05
ti (Taiwan)	58 0.005	110 0.005	160 0.005	320 0.05
mom (momme)	580 0.05	1100 0.05	1600 0.05	3200 0.5
to (to)	180 0.01	360 0.01	530 0.01	1000 0.1

※The view of the table

Upper cell : Capacity
Lower cell : Readability

13. Conversion Table of Units

Unit	Gram	carat	Ounce	Pound	troy ounce	Penny Weight
1g	1	5	0.03527	0.00220	0.03215	0.64301
1ct	0.2	1	0.00705	0.00044	0.00643	0.12860
1oz	28.34952	141.74762	1	0.06250	0.91146	18.22917
1lb	453.59237	2267.96185	16	1	14.58333	291.66667
1ozt	31.10348	155.51738	1.09714	0.06857	1	20
1dwt	1.55517	7.77587	0.05486	0.00343	0.05	1
1GN	0.06480	0.32399	0.00229	0.00014	0.00208	0.04167
1tl (HK)	37.429	187.145	1.32027	0.08252	1.20337	24.06741
1tl (SGP,Mal)	37.79936	188.99682	1.33333	0.08333	1.21528	24.30556
1tl (Taiwan)	37.5	187.5	1.32277	0.08267	1.20565	24.11306
1mom	3.75	18.75	0.13228	0.00827	0.12057	2.41131
1to	11.66380	58.31902	0.41143	0.02571	0.37500	7.5

unit	Grain	tael (Hong Kong)	tael (Singapore, Malaysia)	tael (Taiwan)	momme	Tola
1g	15.43236	0.02672	0.02646	0.02667	0.26667	0.08574
1ct	3.08647	0.00534	0.00529	0.00533	0.05333	0.01715
1oz	437.5	0.75742	0.75	0.75599	7.55987	2.43056
1lb	7000	12.11874	12	12.09580	120.95797	38.88889
1ozt	480	0.83100	0.82286	0.82943	8.29426	2.66667
1dwt	24	0.04155	0.04114	0.04147	0.41471	0.13333
1GN	1	0.00173	0.00171	0.00173	0.01728	0.00556
1tl (HK)	577.61774	1	0.99020	0.99811	9.98107	3.20899
1tl (SGP,Mal)	583.33333	1.00990	1	1.00798	10.07983	3.24074
1tl (Taiwan)	578.71344	1.00190	0.99208	1	10	3.21507
1mom	57.87134	0.10019	0.09921	0.1	1	0.32151
1to	180	0.31162	0.30857	0.31103	3.11035	1

