

High-Precision, Advanced Tuning Fork Balance

HJ-KCE/HJR-KCE Series

Operation Manual

IMPORTANT

- To ensure safe and proper use of the balance, please read this manual carefully.
- After reading this manual, store it in a safe place near the balance, so you can review it as needed.

SHINKO DENSHI CO., LTD.

PREFACE

Thank you for purchasing an HJ-KCE/HJR-KCE Series electronic balance.

This balance is equipped with a high precision mechanism. It provides parts counting, percentage weighing, and limit functions helpful in weighing a certain amount, and has various other functions. This advanced balance employs a user-friendly program, and the key arrangement is also easy to operate. In addition, the large fluorescent display is eye-friendly, and its high-speed, stable performance improves your work efficiency.

Because all the models of the HJ-KCE/HJR-KCE series are dust- and water-proof (conforming to IP65), they can be used in a place exposed to fine dust or to water jets. They can also be washed in water when they are contaminated.

Check for the following accessories before use.

If you find missing or damaged parts, immediately contact the store where you bought the product or our Marketing Division.

- (1) Display (for the separate type or the pole type)
Balance

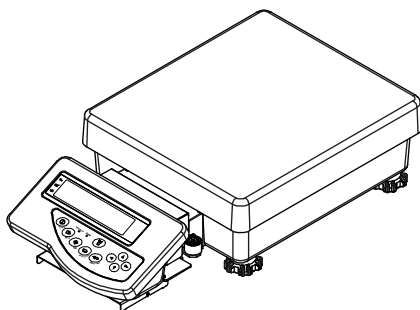

- (2) Cable cover

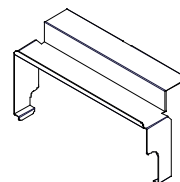
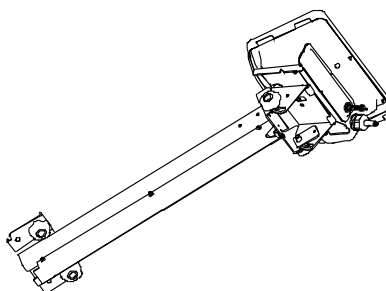

* The display and the balance are connected through a cable, and cannot be separated from each other.

- (3) Base cover

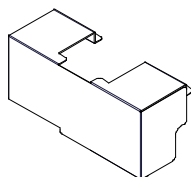

- (4) Connecting fitting (provided for the separate type)

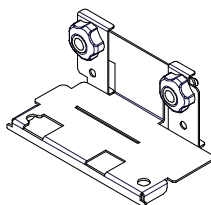

- (5) AC adapter

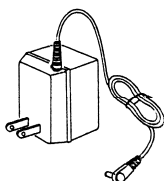

- (6) Operation manual



Contents

1	Precautions Relating to Use.....	2	10	Date and Time Setup.....	36
2	Names of Component Parts	5	11	Various Functions	
			11.1	Auto Sleep Function.....	37
			11.2	Auto Power Off Function.....	37
3	Installation of the Balance and Operation Check		11.3	Set Unit Function	37
3.1	Installation.....	9	11.4	Double Range Function	38
3.2	Operation Check	11	11.5	Date Display	38
4	Function 1		11.6	Time Stamp Output	38
4.1	Setting and Check	14	11.7	Direct Start Function.....	38
4.2	Description of Function 1	15	11.8	Interval Output Function	39
4.3	Limit Function	17	11.9	Enter an ID Number.....	40
4.4	Interface	18			
5	Function 2.....	19	12.	Input/Output Functions	
6	Weighing Mode		12.1	RS232C Output.....	41
6.1	Measurement Modes	20	12.2	Output to Peripherals	44
6.2	Weighing Machine	20	12.3	Type of Communication Texts.....	45
6.3	Parts Counting	21	12.4	Output Data	45
6.4	Percentage Weighing.....	23	12.5	Input Commands	49
7	Addition function.....	25	13	Use Printers	55
8	Limit Function		14	Output in Compliance with ISO/GLP/GMP	56
8.1	Setting the Limit Function	26	15	Operate on Batteries.....	59
8.2	Judgment and Saving	26	16	Troubleshooting.....	60
8.3	Display of Judgment Results.....	26	17	Specifications.....	62
8.4	Judge by Absolute Values	27	18	Conversion Table of Units.....	65
8.5	Judge by Deviation Values	29			
8.6	Bar Graph for the 2-point Scale.....	32			
9	Calibrating and Span Test for the Balance				
9.1	Span Adjustment with Built-in Weight ...	33			
9.2	Span Adjustment with External Weight.	33			
9.3	Span Test with Built-in Weight	34			
9.4	Span Test with External Weight	34			
9.5	Calibration of Built-in Weight.....	35			

1 Precautions Relating to Use

- This Section “Precautions Relating to Use” sets forth precautionary notes that the user should observe in order to prevent physical injury to the user and/or damage to property.
- The nature of problems that may result in the event of improper operation, and consequential effects on the quality and performance of the balance, are indicated under the two categories of “Caution” and “Recommended,” and explained using symbols.

Caution

This is a category to indicate improper handling that may cause physical injury or severe damage to property. Be sure to follow the directions for safe use to avoid serious consequences.

Recommended

This term indicates steps that the user should take to ensure the quality and reliability of the balance.

Meanings of Symbols

Each symbol is accompanied by an instruction.



Mandatory Symbol

: Indicates a “mandatory” action that should be executed without fail.

Example



Check Level



Prohibitive Symbol

: Indicates a “prohibited” action that must not be executed.

Example



Do Not Use

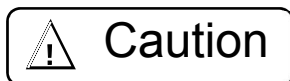

		<p>◆ Do not disassemble or modify the unit.</p> <ul style="list-style-type: none"> • Could cause malfunction or heat generation • Contact your local dealer.
		<p>◆ Only AC power (rated value) should be used.</p> <p>◆ Only use the dedicated AC adapter.</p> <ul style="list-style-type: none"> • Use of other types of power or adapters may result in heat generation or malfunction of the balance.
		<p>◆ Do not move the balance when a sample is loaded.</p> <ul style="list-style-type: none"> • The loaded sample may fall off the measurement pan and cause an injury.



Do Not Use

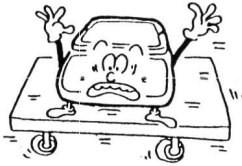

◆ **Do not place the balance on an unstable base or use the balance in a location where it may be subjected to shock.**

- The loaded sample may fall off the measurement pan.
- Accurate measurement may be rendered impossible.



Do Not Drop



◆ **Do not lay the AC adapter cable on the surface of the passage.**

- Somebody may trip on the cable, causing the balance to fall off, thereby causing injury and/or damage to the balance.



Do Not Leave Afloat



◆ **Do not use the balance with its adjusters lifted.**

- The balance will become unstable, preventing accurate measurement.



Do Not Submerge



◆ **Do not submerge the balance.**

- Although the balance is dust- and water-proof, it cannot withstand high water pressure due to submergence under water.

Recommended



Calibrate Balance



◆ **Calibrate the balance after installation or relocation.**

- Measurement values may contain errors, preventing accurate measurement from being conducted.



Do Not Apply Force



◆ **Avoid applying excess force or impact to the balance.**

- Place the sample to be measured on the balance carefully to prevent breakage or malfunction.













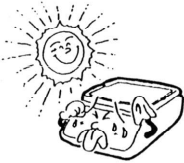

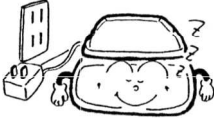
Do Not Use

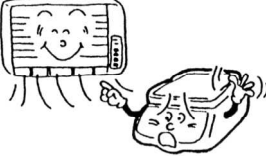

◆ **Do not use the balance in a location where it may be subjected to abrupt changes in ambient temperature or humidity.**

- Accurate measurement may be rendered impossible.
- Use the balance in an ambient temperature between 5°C and 35°C and at a relative humidity of 80%RH or lower.

 Do Not Overload		<p>◆ Do not leave the balance overloaded (When it is overloaded, a series of dots (•••••) is displayed).</p> <ul style="list-style-type: none"> • Take down the loaded sample immediately to prevent breakage or malfunction.
 Do Not Use		<p>◆ Do not use the balance in a location where it is subject to direct sunlight.</p> <ul style="list-style-type: none"> • The indications would be illegible. • An internal temperature increase in the balance may lead to inaccurate measurement.
 Unplug Adapter		<p>◆ If the balance is to be unused for an extended period of time, unplug the adapter.</p> <ul style="list-style-type: none"> • This conserves power and prevents deterioration.
 Do Not Use		<p>◆ Do not use volatile solvents for cleaning.</p> <ul style="list-style-type: none"> • The body may be distorted. • To clean the unit of stains, use a piece of dry cloth or cloth soaked in a small quantity of neutral detergent.
 Do Not Use		<p>◆ Do not use the balance in a location where it may be subject to air from an air-conditioning unit.</p> <ul style="list-style-type: none"> • Extreme changes in the ambient temperature may result in inaccurate measurements.
 Do Not Use		<p>◆ Do not use the balance on a soft floor.</p> <ul style="list-style-type: none"> • When loaded with a sample, the balance may tip or move, preventing accurate measurements from being conducted.
 Check Level		<p>◆ Do not use the balance when it is tilted.</p> <ul style="list-style-type: none"> • When the balance is tilted, an error may be caused, preventing accurate measurement from being conducted. Place the balance on a level surface.

2 Names of Component Parts

2.1 Main Unit

2.1.1 Pole type (HJ[R]-KCE, HJ[R]-KDCE)

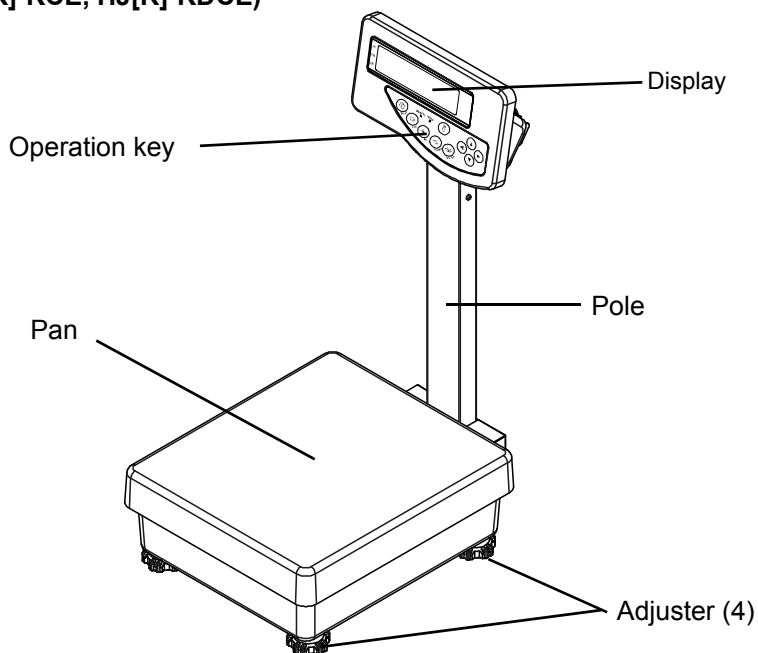

2.1.2 Separate type (HJ[R]-KSCE, HJ[R]-KDSCE)

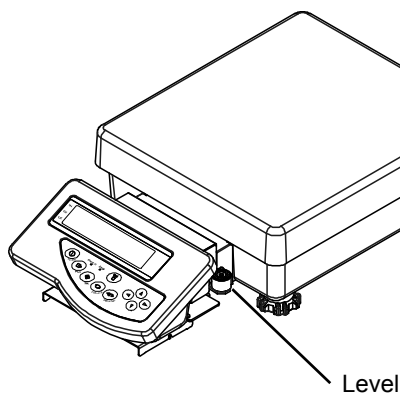

2.1.3 Underside (common to the pole and separate types)

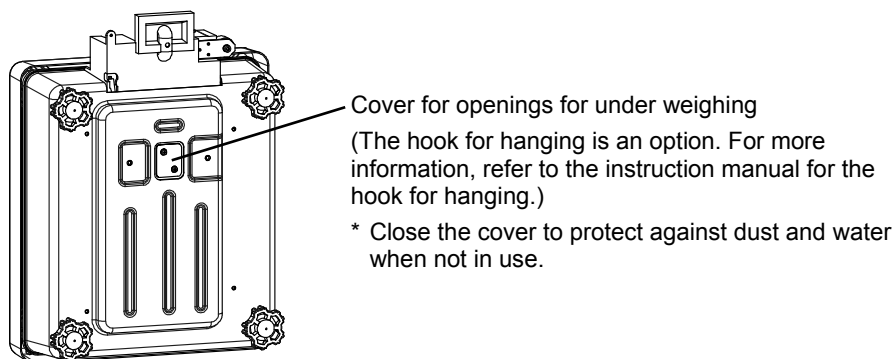

2.2 Display (Backside)

* Common to the separate and pole types.

2.2.1 Backside

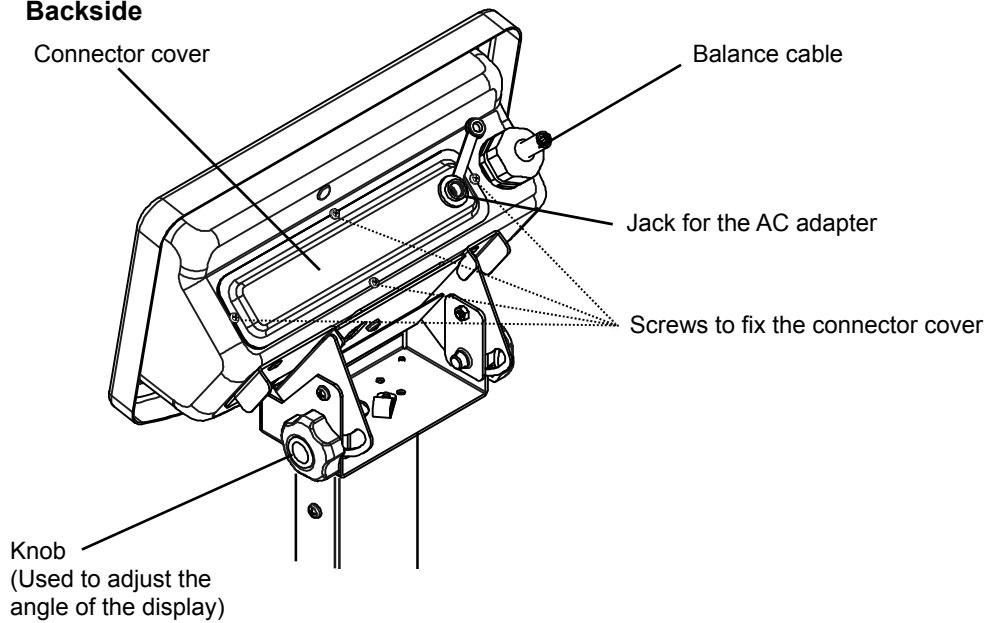

2.2.2 Output connectors (when the connector cover is removed)

To remove the connector cover, unfasten the four screws fixing the cover.

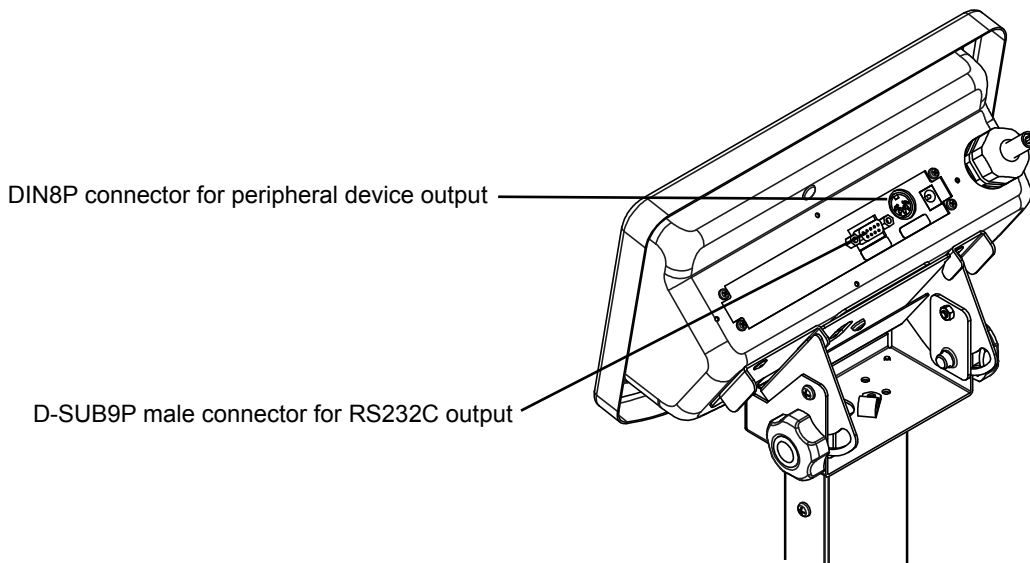

Caution:

When the connector cover is removed, protect them against water. The output connectors are not dust- and water-proof.

When the buzzer output is installed, or the relay output or RS422A output is used, protect the output connectors also against water as they are exposed.

2.3 Displayed Signs and Operation Keys

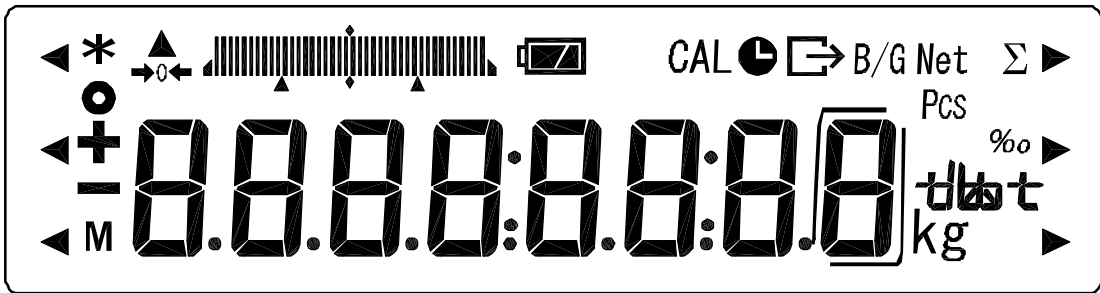





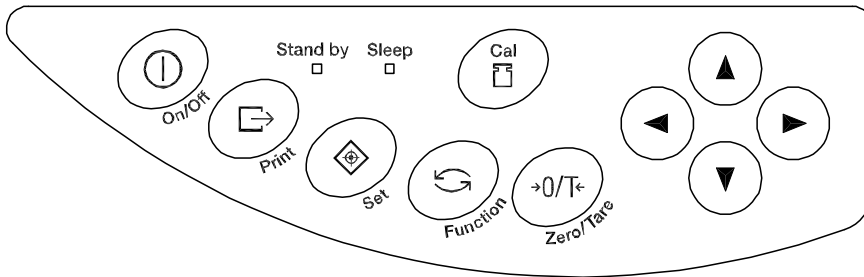

2.3.1 Displayed signs

Display	Description
kg	Kilogram, gram
→0←	Zero point
-	Minus
Net	Tare sign
B/G	Gross weight
○	Indicates stable balance (If this light is off, the balance is unstable.)
*	Indicates that the Addition function is enabled, and withstands additional load.
Pcs	Parts counting
%	Percentage weighing
Σ	Displays a sum total.
⇨	Displayed when data is output in compliance with ISO/GLP/GMP.
🕒	Lights up when outputs are accompanied by a date and time. Blinks during interval output.
◀	Displays a judgment by the limit function (HI/OK/LO).
M	Displays set values from memory (If a value is flashing, it is being saved.)
CAL	Lights up or blinks during span adjustment.
	<ul style="list-style-type: none"> • Bar graph • Displays a judgment by the limit function (scale of 1 to 5) (Refer to Hints on page 33).
	Displays a set unit.
	Battery indicator. As the battery gets weaker, the sign is changed into [] or []. (Refer to Section 15: Operate on Batteries on page 58).
	Lights up only when the auxiliary scale interval is being displayed.

2.3.2 Operation keys and their functions



Operation key		Function
	On/Off key	Turns the balance on or off.
	Print key	Starts output. Also used to cancel the setting of a date and time.
	Set key	[Short press] Starts the setting of a count or a percent. [Long press] Starts the setting of a limit value when the limit function is enabled.
	Function key	[Short press] Switches the measurement mode. [Short press] Used to enter numerical values. [Short press] Used to select a function to set. [Long press] Calls functions.
	Zero/Tare key	[Short press] Sets a zero point or sets a tare weight. [Short press] Used to enter numerical values. [Short press] Used to select a function.
	Cal key	Starts span adjustment or a span test.
	Arrow keys	The arrow keys function in the same way as the Function key or the Zero/Tare key when you set a function or enter numerical values for additional functions.
LED (green)	Stand by	Lights up when the power is on (standby). * The LED does not light up when the balance is operated on batteries.
LED (orange)	Sleep	Lights up when the auto sleep function is enabled.

3 Installation of the Balance and Operation Check

3.1 Installation

3.1.1 Procedure for installing the pole type balance

- ① Lift the pan, and slide it backward.
- ② Loosen the two knobs in the lower part of the pole.
- ③ Insert the pole into the balance so that the cable fits in the groove. Check that the supporting boards are hooked on the bottom of the cable housing.
- ④ Fasten the two knobs in the lower part of the pole.
- ⑤ Fold extra cable and put it in the cable housing. Mount the cable cover vertically on the housing with the both sides slightly opened.
- ⑥ Mount the base cover in the front of the cable housing so that it is hooked on the cable cover.
- ⑦ Put back the pan.
- ⑧ In order to level the balance, turn the adjusters so that the air bubble is centered in the viewer.

* Numbers in the figure below correspond to the above steps to install the balance.

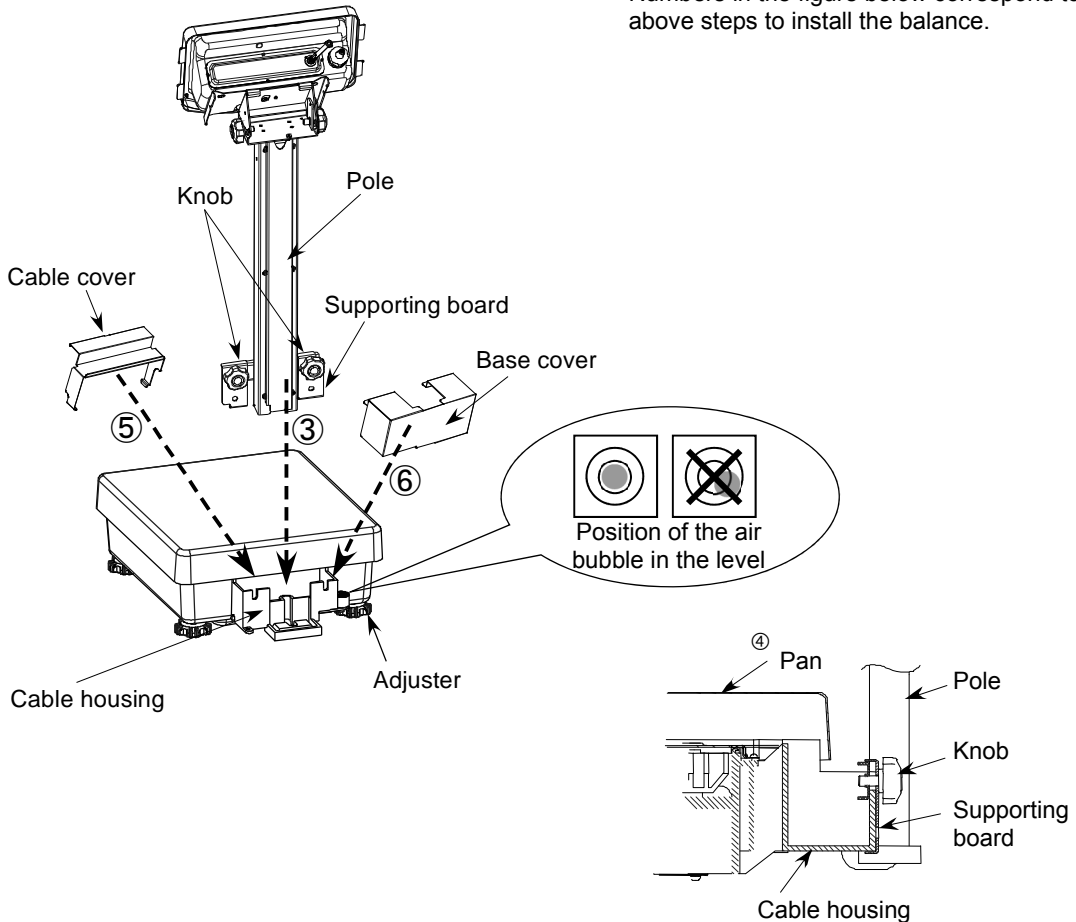

Cross-section View of Pole Installation

3.1.2 Procedure for installing the separate type balance

To use the display and the balance separately from each other

- ① Lift the pan, and slide it backward.
- ② Slightly open both sides of the cable cover, and mount it vertically in the cable housing.
- ③ Mount the base cover in the front of the cable housing so that it is hooked on the cable cover.
- ④ Put back the pan.
- ⑤ In order to level the balance, turn the adjusters so that the air bubble is centered in the viewer.

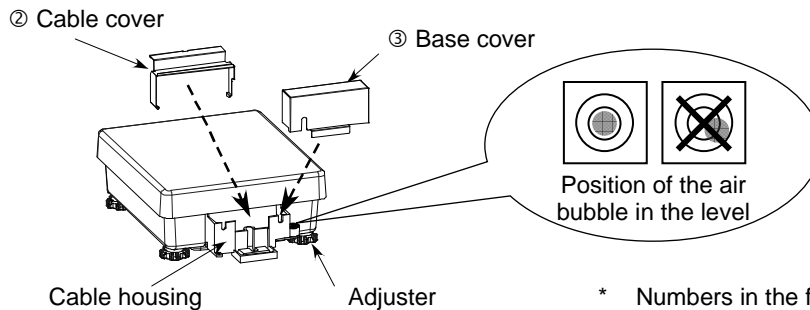

* Numbers in the figure correspond to the above steps to install the balance.

To integrate the display with the balance

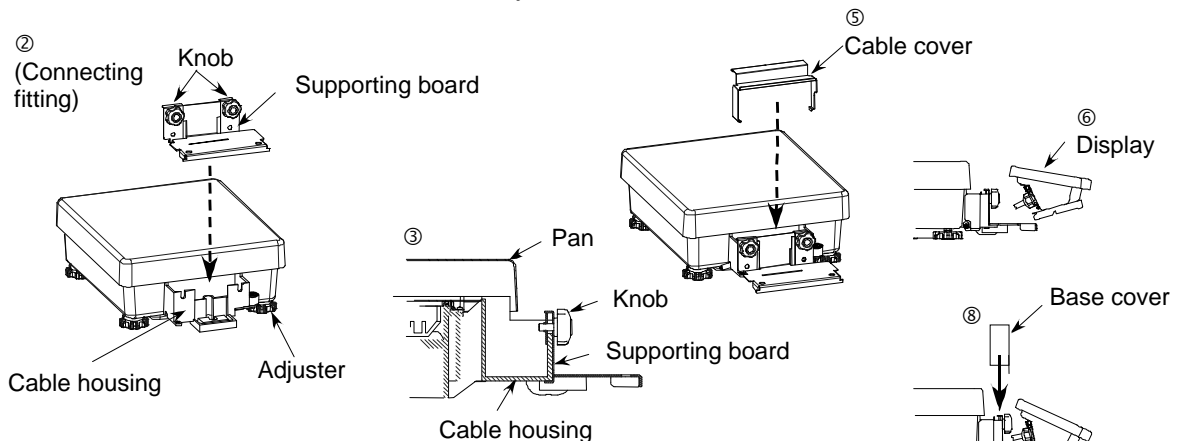

- ① Lift the pan, and slide it backward.
- ② Loosen the two knobs in the connecting fitting, and mount it vertically in the cable housing. Check that the supporting boards are hooked on the bottom of the cable housing.
- ③ Fasten the two knobs in the connecting fitting.
- ④ Fold the cable and put it in the cable housing with 15 cm of the cable left unfolded in the display end.
- ⑤ Slightly open both sides of the cable cover, and mount it vertically in the cable housing.
- ⑥ Insert the display in the connecting fitting at an angle.
- ⑦ Put back the pan.
- ⑧ Mount the base cover vertically.
- ⑨ In order to level the balance, turn the adjusters so that the air bubble is centered in the viewer.



Cross-section View of Connecting Fitting Installation

3.2 Operation Check

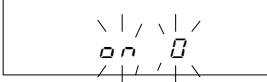
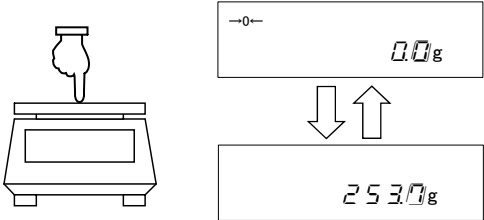
3.2.1 Turn the power on and off and check the display

	<p>Connect the AC adapter. The balance enters standby mode, and the Stand by lamp (LED) lights up.</p> <p>Press the On/Off key. When the display lights up, check it for missing signs.</p>
	<p>When an object is lying on the pan, the blinking "on 0" is displayed. In such cases, remove all the objects on the pan.</p> <p>If a unit other than "g" (gram), "kg" (kilogram) or "ct" (carat) is selected as Unit A, the unit automatically changes to "g."</p>
<p>Check changes of the display.</p> 	<p>Give the pan a slight press, and check that the display is changed.</p> <p>Check that the display goes back to zero when you lift your hand.</p>
<p>Stand by</p> 	<p>Press the On/Off key again. The balance enters standby mode, and the Stand by lamp (LED) lights up.</p>

3.2.2 Set a Tare Weight

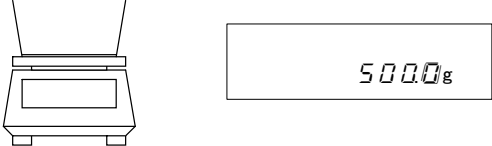
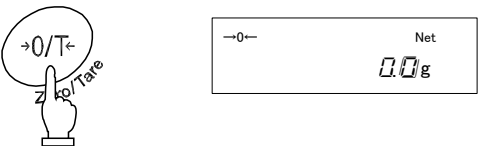
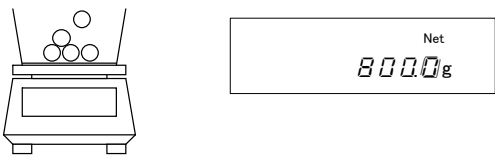
<p>1 Put tare (container) on the balance.</p> 	<p>Put tare on the balance, and the weight is displayed.</p>
<p>2 Reset the display to 0.</p> 	<p>Press the Zero/Tare key. The tare weight is set, and the display is reset to zero.</p>
<p>3 Put a sample on the balance.</p> 	<p>The net weight of the sample in the container is displayed.</p>

☆ Weigh additional samples

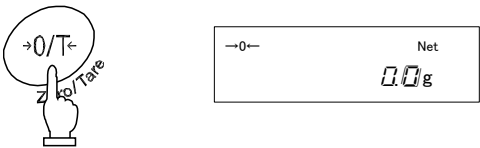
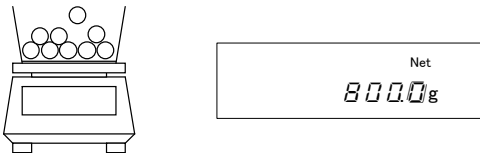
<p>4 Reset the display to 0.</p> 	<p>Press the Zero/Tare key. The gross weight of the sample on the pan is reset to 0.</p>
<p>5 Put an additional sample on the balance.</p> 	<p>The weight of the additional sample is displayed. In this way, you can add a sample and weigh it by pressing the Zero/Tare key to reset the displayed weight to 0.</p>

3.2.2 Display a gross weight

This balance has a function to display a gross weight including a sample and tare. A sample weight including tare is referred to as a gross weight, and a sample weight excluding tare is referred to as a net weight. A gross weight can only be displayed when the balance is used as a weighing machine.

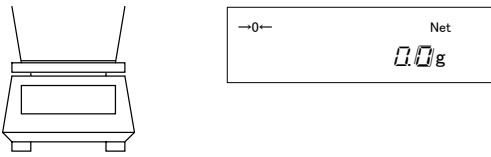
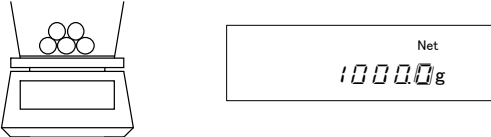
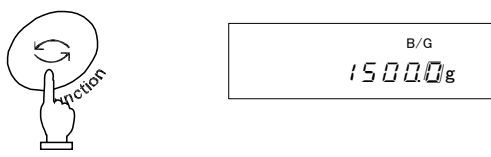
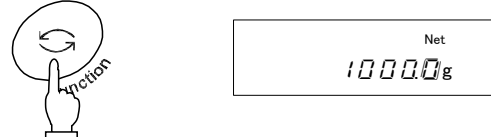
	<p>Put tare on the balance to set the tare weight.</p>
	<p>Put a sample to weigh on the balance. The net weight of the sample is displayed.</p>
	<p>Press the Function key one time. The gross weight including the tare weight is displayed. The B/G sign is displayed.</p>
	<p>When you press the Function key again, the balance is reset to the normal mode.</p>

Caution:

1. A gross weight can only be displayed when the balance functions as a weighing machine.
2. When a gross weight is displayed, you cannot set a tare range. You can only adjust the zero point.

☆ Hints ☆

The following description applies commonly to the weighing machine, parts counting, and percentage weighing functions.

1. A small amount of current is still flowing after the balance is turned off.
In a standby state, the Stand by lamp (LED) is lit. When the balance is turned on, the LED goes out.
*The LED does not light up when the balance is operated on batteries.
2. The bar graph indicates the current load condition in relation to the weighing capacity. As the load approaches the weighing capacity, the bar gets closer to the right end.
*When a tare range is set, the weight is reflected in the bar even though the display indicates [O].
3. When the balance is stable, a circle is displayed. When it gets unstable, the sign goes out. When the balance is affected by wind or vibration, numeric values on the display may flicker or the sign to indicate that the balance is stable may go out. In that case, improve the stability by resetting Function 1 (refer to page 14) according to the following table.

Influence of wind or vibration	Stability Judgment	Response Speed
Small	2	1
↕	3	2
Large	4	3

If the influence of the wind or vibration is small, set these setting items of Function 1 higher. Set these items lower as the influence is increased.

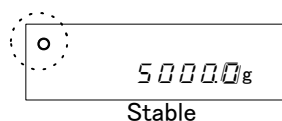
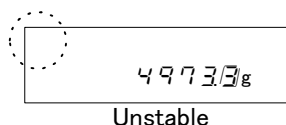

4. When you reset the display to 0 or set a tare range, the display indicates 0, and the [→0←] sign is displayed. When you set a tare range, the [Net] sign is displayed.



* When the zero point deviates from the true zero point by one fourth of a division, the →0← sign goes out





* When you set a tare range, the display indicates 0, and the Net sign is displayed.

5. When a tare range is set, the weighing capacity is reduced accordingly. Weighing capacity = original weighing capacity – tare weight
6. A series of dots [▯ - E r r] displayed after an object is put on the balance, indicates that the weighing capacity is exceeded.
7. When you remove the pan, and the zero point falls below the original zero point, a series of dots [▯ - E r r] is displayed.
8. When you select the parts counting function or the percentage weighing function, the display still indicates zero when you press the pan until the weight of a sample is stored.
9. When you turn on the balance, it starts in the mode when it was turned off. For example, if you turn off the balance in the parts counting mode, it starts in the parts counting mode when it is turned on the next time.

4 Function 1

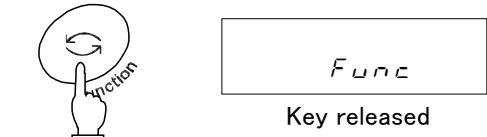
4.1 Setting and Check

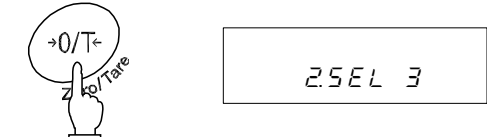
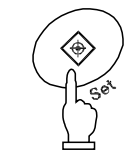
<p>1. Call Function 1.</p>  <p>Continuous press</p> <p>Key released</p>	<p>Press and hold down the Function key until a series of dots [<i>F u n c</i>] is displayed.</p> <p>Now you can set Function 1. The first setting item is displayed [<i>1 S E T 1</i>]. (Refer to Section 4.2: Description of Function 1 on page 15).</p>
<p>2. Select the next setting item.</p> 	<p>Every time you press the Function key, you are moved one item forward.</p>
<p>3. Change settings.</p> 	<p>Every time you press the Zero/Tare key, the value in the right end is changed. Make appropriate settings.</p>
<p>4. Complete the setting of functions.</p> 	<p>Press the Set key, or press the Function key several times until the balance enters measurement mode.</p> <p>The setting of functions is completed, and the balance goes back into measurement mode.</p>

* The setting values of Function 1 are held after the power is turned off.

Use the arrow keys to set function

It will become easier to set up functions with the arrow keys in the right-hand side of a display.

While displaying the item of a function 1, you can use the arrow keys to set up functions instead of the **Zero/Tare** key or the **Function** key. The arrow keys can be used as shown in the following figure:

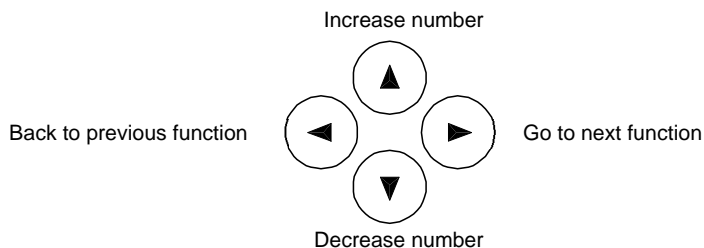

4.2 Description of Function 1

Item	Set Value	Description		
Weighing Mode	1. <i>SEL.</i>	☆1	Weighing machine (only supports weight measuring)	
		2	Parts counting (parts counting and weight measuring)	
		3	Percentage weighing (weight percent measuring and weight measuring)	
Additional Functions	2. <i>SEL</i>	☆0	Disable additional functions.	
		1	Addition function	
		2	Limit function	
		3	Cumulate and limit functions	Refer to Section 4.3: Limit Function.
Auto-Zero (Zero Tracking)	3. <i>RD</i>	0	Disable	Automatically adjust even a slight deviation of the zero point.
		☆1	Enable	
Stability Judgment	4. <i>SD</i>	☆2	Wide (Mild)	
		3	↓	
		4	Narrow (Strict)	
Response Speed	5. <i>RE</i>	0	Measurement by consecutive weighings	
		1	Fast	
		2	↓	
		☆3	Slow	
Interface	6. <i>IF.</i>	0	Stop input/output	
		☆1	Numeric 6-digit format	Refer to Section 4.4: Interface.
		2	Numeric 7-digit format	
3	Extended 7-digit numeric format			
Span Adjustment Span Test	7. <i>CR</i> ☆3	0	Disable the Cal key.	
		☆1 1	Span adjustment with built-in weight (Auto-span adjustment)	
		2	Span test with built-in weight	
		3*	Span adjustment with external weight	
		☆2 4	Span test with external weight	
Bar Graph	8. <i>BG.</i>	0	Hide the bar graph.	
		☆1	Display the bar graph.	
Auto Power Off	9. <i>R.P.</i>	0	Disable (for continuous use)	Available only when the balance is operated on batteries.
		☆1	Enable (the power is turned off 3 minutes later)	
Auto Sleep	10. <i>RS.</i>	0	Disable	
		☆1	The balance goes into sleep mode 3 minutes later when it is operated on AC power.	
Unit A	11. <i>UR</i>	☆1	[g]	
		2	[kg]	
		4	[ct] (ct)	

A star (☆) denotes a factory setting.

☆1 denotes a factory setting for the HJR-KCE series, and ☆2 denotes a factory setting for the HJ-KCE series.

☆3 The HJ-KCE series does not display [7. CR 1] or [7. CR 2].

*Can be set only for a model on which the lock switch is off.

Item		Set Value	Description	
Unit B		<i>b3 ub</i>	☆0	None
			1	[g]
			2	[kg]
			4	[ct] (ct)
Auxiliary display ☆4		<i>E R1</i>	0	Without auxiliary display
			☆1	With auxiliary display
Double Range		<i>E dr</i>	0	Disable
			☆1	Enable
			Only HJR-62KD[S]CE and HJ-62KD[S]CE display this setting item.	
Compliance with ISO/GLP/GMP		<i>E GLP</i>	☆0	Disable
			1	Enable
Compliance with ISO/GLP/ GMP is enabled. Displayed when GMP is enabled.	Output of Calibration Result	<i>E1 out</i>	0	Disable
			☆1	Enable
	Data Compliant with GLP	<i>E2 od</i>	☆0	Disable
			1	Enable
Printed Language	<i>E3 P.F.</i>	☆1	English	
		2	Japanese (Katakana)	
Date Display		<i>F date</i>	1	Output in Year-Month-Day format.
			2	Output in Month-Day-Year format.
			☆3	Output in Day-Month-Year format.
Time Stamp Output		<i>G t.o.</i>	☆0	Disable
			1	Output measurement data with time.
Direct Start		<i>L d.st.</i>	☆0	The balance goes into standby mode when the AC adapter is inserted.
			1	The balance is turned on when the AC adapter is inserted.
Auxiliary scale interval output format ☆4 ☆5		<i>n P.r.F</i>	1	Is not output when an auxiliary scale interval is being displayed.
			2	Is output in the normal format even when an auxiliary scale interval is being displayed.
			☆3	A slash "/" is output in the digit preceding the auxiliary scale interval.

A star (☆) denotes a factory setting.

☆4 Can be selected only with models which have an auxiliary scale interval.

☆5 Can be selected only while the instrument is not sealed.

4.3 Limit Function

Displayed when [2 SEL] is [2] or [3].

Item	Set Value	Description
Condition	21 Co	★1 Always judge (even when the balance is unstable).
		2 Judge only when the balance is stable.
Range to Cover	22 Li	0 Detect when the limit is exceeded by more than 5 divisions (Do not detect when the limit is exceeded by 5 or fewer divisions or the limit is not reached).
		★1 Detect both when the limit is exceeded and when it is not reached.
Point Scale	23 Pi	1 1-point scale (OK/LO)
		★2 2-point scale (HI/OK/LO)
		3 3-point scale (scale of 1 to 4)
		4 4-point scale (scale of 1 to 5)
Judge by	24 tYP	★1 Judge by absolute values.
		2 Judge by deviation values.
Buzzer for rank 1	25 bu1	★0 Do not sound a buzzer for rank 1 (LO).
		1 Sound a buzzer for rank 1 (LO).
Buzzer for rank 2	26 bu2	★0 Do not sound a buzzer for rank 2 (OK).
		1 Sound a buzzer for rank 2 (OK).
Buzzer for rank 3	27 bu3	★0 Do not sound a buzzer for rank 3 (HI).
		1 Sound a buzzer for rank 3 (HI).
Buzzer for rank 4	28 bu4	★0 Do not sound a buzzer for rank 4.
		1 Sound a buzzer for rank 4.
Buzzer for rank 5	29 bu5	★0 Do not sound a buzzer for rank 5.
		1 Sound a buzzer for rank 5.
How to Indicate Results	2R LG	★1 Display HI, OK, or LO.
		2 Bar graph for the 2-point scale (Available only when you select the 2-point scale)
Relay Output Control	2b r.o.c.	★1 Output all the time (independently of external signal input).
		2 Control by external signal input. *

* Set [2b r.o.c. 2] when the limit contact output option or the full pack option is used. Otherwise, use [2b r.o.c. 1].

4.4 Interface

Displayed unless input/output is stopped in Interface of Function 1.

Item	Set Value	Description	
Output Control	E1 O.C. ☆6	0	Stop output
		1	Output continuously at all times
		2	Output continuously if stable (Stop output if unstable)
		3	Output once when the Print key is pressed (whether the balance is stable or unstable).
		4	Output once when the balance is stable. Output when a substance is lifted to cause the display to indicate a value below 0, and then another substance is put on to make the balance stable.
		5	Output once when the balance is stable. Stop output when unstable. Output once when the balance is stabilized again even if it is not reloaded (the output includes zero).
		6	Output once when the balance is stable. Output continuously when unstable. Output is stopped after a single output when the balance is stable even if it is not reloaded.
		☆7	Output once when Print key is pressed if the balance is stable.
		R	Output once immediately after a specified interval.
b	Output once immediately after a specified interval if the balance is stable.		
Baud Rate	E2 B.L.	☆1	1200 bps
		2	2400 bps
		3	4800 bps
		4	9600 bps
		5	19200 bps
Parity	E3 P.R.	☆0	None
		1	Odd
		2	Even
Data Length	E4 d.L.	7	7 bits
		☆8	8 bits
Stop Bits	E5 S.L.	1	1 bit
		☆2	2 bits
Unused High Order Digits	E6 u.r.	☆0	Embed 0 (30H).
		1	Embed space (20H).
Response Commands	E7 r.E.S.	☆1	Use A00 and Exx.
		2	Use ACK and NAK.



A star (☆) denotes a factory setting.

The data interval in continuous output is 0.1 to 1 second. (The interval varies depending on the state of weighing and other factors.)

☆6 To connect this instrument to a printer, select one numeral or letter from among 0, 2, 4, 5, 7, and b.

5 Function 2

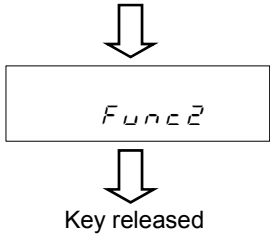
5.1 Setting and Check

<p>1 Call Function 2.</p> <p>Press the Function key while holding down the Zero/Tare key.</p>  <p>The diagram shows a rectangular display box containing the text 'Func 2'. Above the box is a downward-pointing arrow, and below the box is another downward-pointing arrow. Below the second arrow, the text 'Key released' is written.</p>	<p>Press the Function key while holding down the Zero/Tare key.</p> <p>When a series of dots [<i>F u n c 2</i>] is displayed, release the key.</p> <p>The display is changed to [<i>1 1d 0</i>].</p>
<p>2 Change settings.</p>  <p>The diagram shows a rectangular display box containing the text '1 1d 1'.</p>	<p>Select setting items to change with the Function key. Change the setting in the right end with the Zero/Tare key.</p>
<p>3 Complete the setting of functions.</p>	<p>Press the Set key, or press the Function key several times until the balance enters measurement mode. The setting of Function 2 is completed, and the balance goes back into measurement mode.</p>

5.2 Description of Function 2

Item	Set Value	Description
Setup of ID No.	<i>1 1d</i>	☆0 Disable function
		1 Enable
Calibration of Built-in Weight *1	<i>2 r.c.R.</i>	☆0 Disable function
		1 Enable

A star (☆) denotes a factory setting.

*1 This instrument cannot be used when it is sealed.

Caution:

The setting values of Function 2 are reset to factory defaults every time you call it.

6 Weighing Mode

You can select a Weighing Mode from four types in Function 1: weighing machine, parts counting, and percentage weighing. All the Weighing Mode support additional functions (or the Addition function and the limit function) depending on the unit to use.

6.1 Measurement Modes

When you select a Weighing Mode and additional functions, you can weigh samples in different ways as shown below. Every time you press the **Function** key, the measurement mode is switched.

Weighing Mode	Measurement Mode		Additional Functions		Remarks
	Unit	Function	Cumulate	Limit	
Weighing machine	Unit A	Weight measuring	○	○	
	Unit A (B/G)	Gross weight	×	×	
	Unit B	Weight measuring	×	×	
	Unit A (Σ)	Cumulative weight	Display	×	
Parts counting	Pcs	Counting	○	○	
	Σ Pcs	Cumulative count	Display	×	
	Unit A (Pcs)	Average unit weight	×	×	
	Unit A	Weight measuring	×	×	
Percentage weighing	%	Percent measuring	○	○	
	Σ %	Cumulative percent	Display	×	
	Unit A	Weight measuring	×	×	

* You can select **g**, **kg**, or another unit for Unit A and Unit B.

○: Supports both measurement and display.

×: Does not support measurement or display.

Display: The cumulative value is displayed.

6.2 Weighing Machine

The weighing machine function only supports **g**, **kg**, and other units of weight. This function also allows the display of a gross weight (refer to page 12).

6.3 Parts Counting

The parts counting function employs an automatic memory update method, also referred to as a Self Counting System. When you put a specified number of samples on the balance, and put additional samples, the balance automatically updates the average unit weight of the samples. However, you cannot add more than three times as many samples as the first reading. This mechanism allows accurate counting.

6.3.1 Sampling

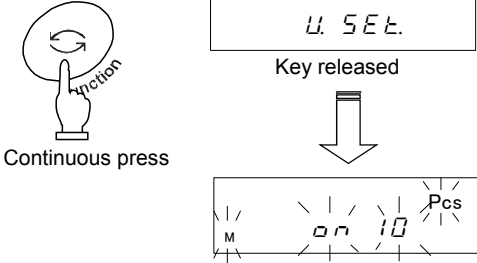
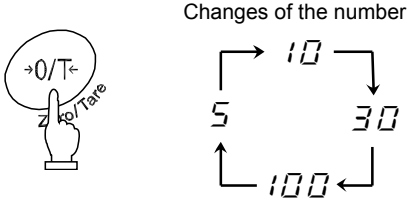
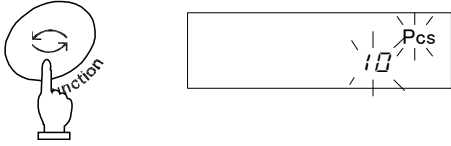
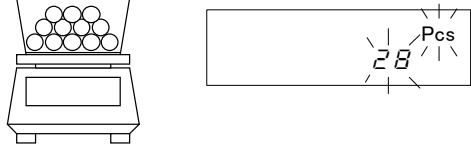
<p>1 Select the parts counting function.</p> 	<p>Select the parts counting function in Function 1 [1 SEt. 2].</p> <p>Put tare on the balance.</p>
<p>2 Start sampling.</p> 	<p>Press the Function key for a few seconds.</p> <p>When the display indicates [U SEt.], release the key.</p> <p>The display then blinks [00 10 Pcs]. This indicates to put 10 samples on the balance.</p>
<p>3 Change the number of samples as required.</p> 	<p>If the samples vary considerably in size, or are light in weight, press the Zero/Tare key to change the number of samples.</p> <p>Every time you press the key, the value in the right end is changed. Select an appropriate value.</p> <p>If you do not need to change the number, skip this step.</p>
<p>4 Put a sample on the balance.</p> 	<p>Put the displayed number of samples on the balance, and press the Function key.</p> <p>The display then blinks [10 Pcs].</p>
<p>5 Put additional samples on the balance.</p> 	<p>When you add samples, the balance updates the memory unless you add more than three times as many samples as the displayed number.</p>

6 Save the unit weight of the samples.

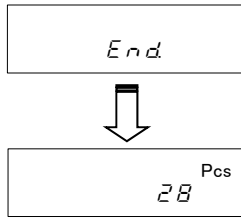
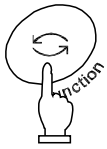

Press the **Function** key to complete the update of the memory.

The balance goes back into measurement mode.

★Hints ★

1. A series of dots [$S \cdot b$] displayed during memory update indicates that you added more than three times as many samples as the displayed number and the counting accuracy is low. Do not add too many samples at a time. Gradually increase the number of samples to increase counting accuracy.
2. A series of dots [$R \cdot d$] displayed during memory update indicates that the number of samples you added is too small and the counting accuracy is low. Add samples until these dots are turned off to increase counting accuracy.
3. When these indications are displayed, you can press the **Function** key to store the average unit weight. In this case, however, counting accuracy is low, and a counting error may be caused.
4. A series of dots [$L - E r r$] may be displayed to indicate that the average unit weight is too small for the balance to count the samples.
The minimum unit weight supported by the parts counting function depends on the model. For more information, refer to Section 17: Specifications on page 62.

6.4 Percentage Weighing

6.4.1 Set a reference weight by weighing an actual sample

You can make the display indicate the weight percentage (%) of a sample with respect to a reference sample weight.

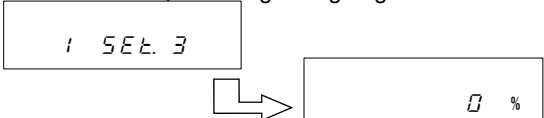
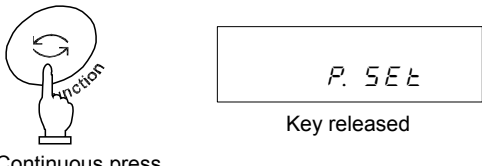
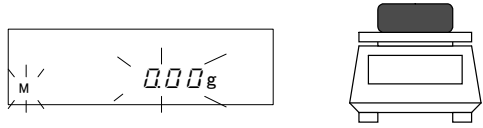
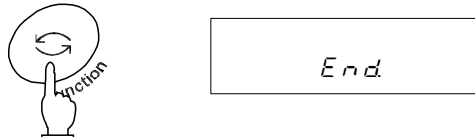
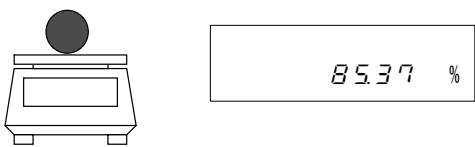
<p>1 Select the percentage weighing function.</p> 	<p>Select the percentage weighing function in Function 1 [1 SEt. 3].</p>
<p>2 Set a reference weight.</p>  <p>Continuous press</p>	<p>Press the Function key for a few seconds. When the display indicates [P. SEt.], release the key.</p> <p>The display blinks a weight. If you have set a reference weight before, that value is displayed.</p>
<p>3 Put a sample on the balance.</p> 	<p>The display blinks a weight. If you have set a reference weight before, that value is displayed. Put the reference sample on the balance.</p>
<p>4 Save the reference weight.</p> 	<p>Press the Function key.</p> <p>The balance beeps to indicate that the reference weight was saved, and then goes back into measurement mode.</p>
<p>5 Put a sample to weigh on the balance.</p> 	<p>The display indicates the weight percentage (%) of the sample with respect to the reference.</p>

Caution:

The minimum unit is automatically selected, depending on the saved reference weight.

Min. Indication	Range of Reference Weight
L - E r r	Reference weight < Lower weight limit
1%	Lower weight limit ≤ Reference weight < Lower weight limit × 10
0.1%	Lower weight limit × 10 ≤ Reference weight < Lower weight limit × 100
0.01%	Lower weight limit × 100 ≤ Reference weight

You cannot set a value below the lower weight limit as a reference weight.

* The lower weight limit depends on the model. For more information, refer to Section 17: Specifications on page 62.

6.4.2 Set a reference weight by entering a value

You can enter a reference weight in the balance, and then make the display indicate the weight percentage (%) of a sample with respect to the reference.

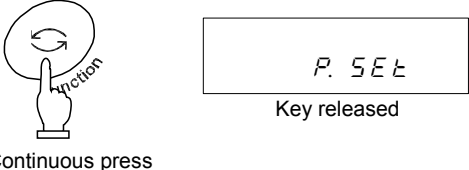
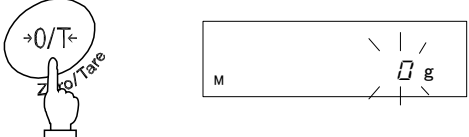
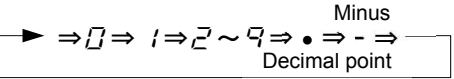
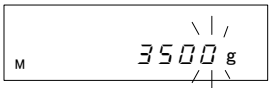
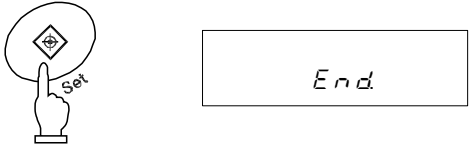
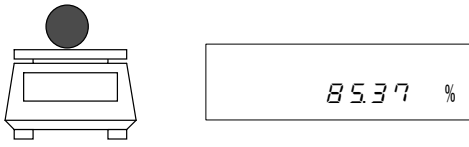
<p>1 Set a reference weight.</p>  <p>Continuous press</p>	<p>Press the Function key for a few seconds. When the display indicates [P. SEt.], release the key. The display blinks a weight. If you have set a reference weight before, that value is displayed.</p>
<p>2 Enter a reference weight.</p> 	<p>Press the Zero/Tare key. A dot (.) blinks in the right end of the display.</p>
<p>3 Select a number.</p>  <p>Minus Decimal point</p>	<p>Every time you press the Zero/Tare key, the number changes.</p>
<p>4 Select digit places to specify a reference weight.</p> 	<p>Press the Function key, and the specified number shifts to the left, and you can enter the next digit.</p>
<p>5 Save the reference weight.</p> 	<p>Press the Set key. The balance beeps to indicate that the reference weight was saved, and then goes back into measurement mode.</p>
<p>6 Put a sample to weigh on the balance.</p> 	<p>Put a sample to weigh on the balance. The display indicates the weight percentage (%) of the sample with respect to the reference.</p>

Use the arrow keys to enter values

You can use the arrow keys to enter values instead of the **Zero/Tare** key or the **Function** key.

The arrow keys can be used as shown in the following figure:

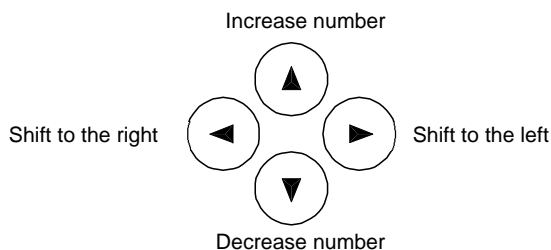

7 Addition function

The Addition function allows you to find the cumulative weight of samples put on the balance one after another. All of the weighing machine, parts counting, and percentage weighing functions support the Addition function.

With the cumulate function, a cumulative weight can be obtained while samples are reloaded.

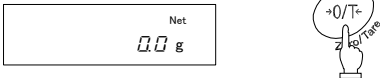
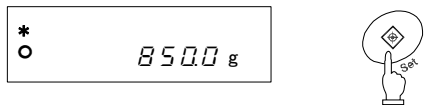
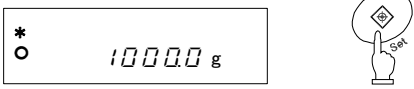
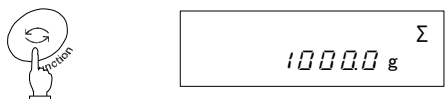
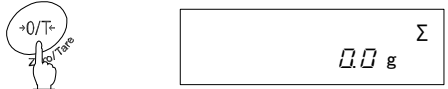
<p>1 Set Function 1.</p> 	<p>Set Function 1 from [2.5EL 1] to [2.C Adn 1].</p>
<p>2 Reset the display to 0.</p> 	<p>Press the Zero/Tare key for zero adjustment or for tare range.</p>
<p>3 Put samples on the balance, and obtain the weight.</p> 	<p>Put samples to weigh on the balance. When the asterisk (*) sign is displayed, you can put additional samples on. When [0] is displayed, press the Set key. The displayed value is added, and the cumulative value is displayed with the [Σ] sign for several seconds.</p>
<p>4 Put another sample on the balance.</p>	<p>Unload the balance, check that the display indicates 0, and put different samples on.</p>
<p>5 Read the weight.</p> 	<p>When [0] is displayed, press the Set key. After it is stabilized, the displayed value is added, and the cumulative weight is displayed with the [Σ] sign for several seconds.</p>
<p>6 Display the cumulative weight.</p> 	<p>Press the Function key twice. The sign [Σ] will be lit and the cumulative value will be shown. (The number of times the Function key is pressed depends on the type of the balance.)</p>
<p>7 Clear the cumulative weight.</p> 	<p>Press the Zero/Tare key with the cumulative weight displayed (step 4) to reset the display to 0.</p>

Obtain a cumulative weight without reloading the balance

	<p>Press the Zero/Tare key in step 2 without unloading the balance. This will reset the display to 0. Put additional samples on, and press the Set key. Then, the weight is cumulated.</p>
---	--

Caution:

- Put additional samples on when the display indicates zero.
- When [L - E r r] is displayed when you press the **Set** key, it indicates that you put additional samples on twice, that you unloaded some samples, or that you pressed the key without adding samples.
- You can add samples when an asterisk (*) is displayed.

8 Limit Function

The limit function judges a weight based on limit values that you have stored on the balance.

When one or two points are set, a dot (◀) is displayed next to one of HI (high), OK (proper), and LO (low) to indicate the result. When three or four points are set, the judgment result is displayed as a bar graph to indicate a rank.

8.1 Setting the Limit Function

Make the settings of the limit function in Function 1. The limit function provides different setting items. Read Section 4.3: Limit Function carefully to set them.

8.2 Judgment and Saving

A limit value can be judged in the following two ways. Select an appropriate one in Function 1.

- (1) Judge by absolute values Specify an upper weight limit or a lower weight limit directly.
- (2) Judge by deviation values Specify an upper limit or a lower limit with respect to a reference weight.

A limit value can be stored in the following two ways. They can be used in combination with either of the above judgment methods.

- (1) Put actual samples on the balance.....Put an actual sample on the balance, and save the weight as a limit value.
- (2) Enter values.....Enter a limit value using the keys.

- * Once a limit value is entered, it is held after the balance is turned off.
- * You can set separate limit values for the weighing machine, parts counting, and percentage weighing functions.
- * When you enter a limit value, it is treated differently between the two judgment methods. (Refer to Caution 9 on page 32).

8.3 Display of Judgment Results

When one or two points are set, a dot (◀) is displayed next to one of HI, OK, and LO in the left of the display.



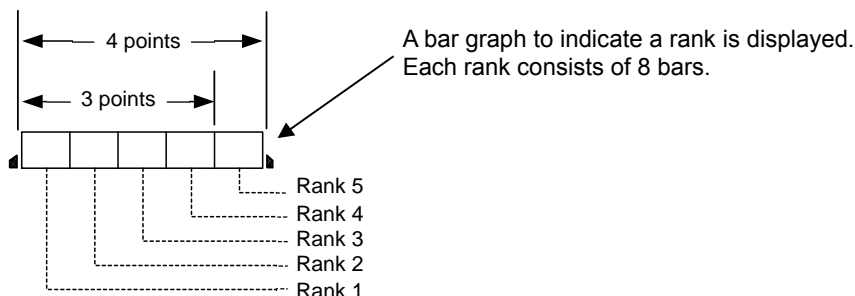

Judgment Result	When one point (lower limit) is set	When two points (lower and upper limits) are set
HI (high)	N/A	Weight > Upper limit
OK (proper)	Lower limit ≤ Weight	Lower limit ≤ Weight ≤ Upper limit
LO (low)	Lower limit > Weight	Lower limit > Weight

When three or four points are set, a bar graph is displayed to indicate a rank.

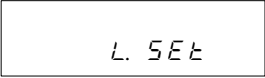
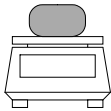

8.4 Judge by Absolute Values

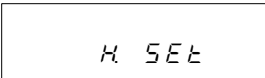
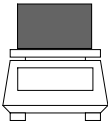

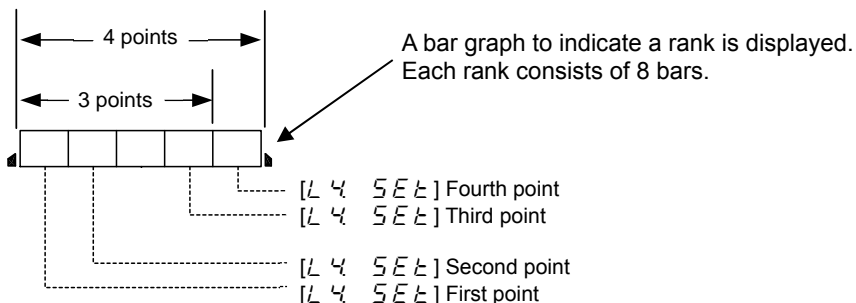

8.4.1 Set two limit values by putting actual samples on the balance

<p>1 Start the limit function.</p>  <p>Continuous press</p> 	<p>Press the Set key for a few seconds. When the display indicates [L. SET], release the key.</p> <p>The current lower limit is displayed next to [LO ◀].</p>
<p>2 Put the lower limit sample on the balance.</p> 	<p>Put the lower limit sample on the pan.</p>
<p>3 Save the lower limit.</p> 	<p>Press the Function key. When a lower limit is saved, that value is displayed for a while. * To set only one point, ignore the following steps.</p>
<p>4 Set an upper limit.</p> 	<p>The display then indicates [H. SET], and you can now set an upper limit. The current upper limit is displayed next to [HI ◀].</p>
<p>5 Put the upper limit sample on the balance.</p> 	<p>Put the upper limit sample on the pan.</p>
<p>6 Save the upper limit.</p> 	<p>Press the Function key. When an upper limit is saved, that value is displayed for a while. Then the balance goes back into measurement mode.</p>

- * To set three or four points, repeat steps 2 through 3 above.
Saved limit values are displayed as [L 1 SET]-[L 3 SET] or [L 4 SET] rather than [L. SET] or [H. SET]. In this case, a bar graph is displayed to indicate a rank.



8.4.2 Set two limit values by entering values

<p>1 Start the limit function.</p>  <div style="border: 1px solid black; padding: 5px; display: inline-block; margin-left: 20px;">L. SEt</div> <p>Continuous press</p>	<p>Press the Set key until the display indicates [L. SEt].</p> <p>The current lower limit is displayed next to [LO ◀].</p>
<p>2 Switch to the value input screen.</p> 	<p>Press the Zero/Tare key.</p> <p>A dot (◻) blinks in the right end of the display.</p>
<p>3 Enter a number.</p> <div style="border: 1px solid black; padding: 5px; display: inline-block; margin-left: 20px;"> ▶ ⇒ 0 ⇒ 1 ⇒ 2 ~ 9 ⇒ • ⇒ - ⇒ </div> <p style="margin-left: 100px;">Minus Decimal point</p>	<p>Press the Zero/Tare key to change the blinking number. Every time you press the key, the number changes.</p>
<p>4 Select digit places.</p> 	<p>Press the Function key, and the specified number shifts to the left, and you can enter the next digit.</p>
<p>5 Save the lower limit.</p> 	<p>Press the Set key.</p> <p>When a lower limit is saved, that value is displayed for a while.</p> <p>(To set only one point, ignore the following steps).</p>
<p>6 Set an upper limit.</p> <div style="border: 1px solid black; padding: 5px; display: inline-block; margin-left: 20px;">H. SEt</div>	<p>The display then indicates [H. SEt], and you can now set an upper limit.</p> <p>The current upper limit is displayed next to [HI ◀].</p>
<p>7 Enter an upper limit.</p>	<p>Repeat steps 2 to 5 to enter an upper limit.</p>
<p>8 Save the upper limit.</p> 	<p>Press the Set key. The upper limit is saved, and the balance goes back into measurement mode.</p>



You can use the arrow keys to enter values instead of the **Zero/Tare** key or the **Function** key (Refer to page 24).

* To set three or four points, repeat steps 2 through 5 above.

Saved limit values are displayed as [L 1 SEt] - [L 3 SEt] or [L 4 SEt] rather than [L. SEt] or [H. SEt]. In this case, a bar graph is displayed to indicate a rank.

8.5 Judge by Deviation Values

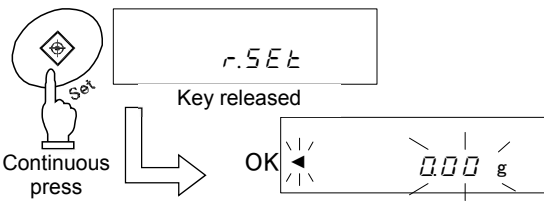
8.5.1 Set two limit values by putting actual samples on the balance

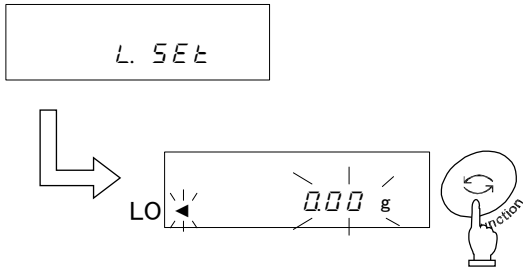
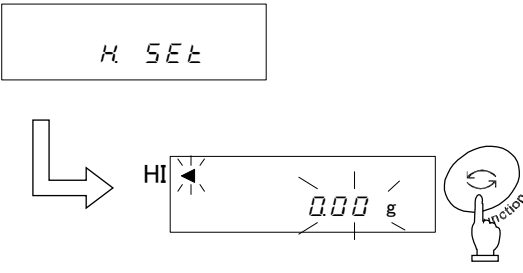
<p>1 Start the limit function.</p>  <p>Continuous press</p> <p>Key released</p> <p>OK</p>	<p>Press the Set key for a few seconds.</p> <p>When [r. S E t] is displayed, release the key.</p> <p>The current reference weight blinks in the display.</p>
<p>2 Save the reference weight.</p> 	<p>Put a sample that provides a reference weight on the balance, and press the Function key.</p> <p>When a reference weight is saved, that value is displayed for a while.</p>
<p>3 Save a lower limit.</p> 	<p>The display first indicates [L. S E t.], and then the current lower limit blinks.</p> <p>Put a sample that provides a lower limit on the balance, and press the Function key.</p> <p>A lower limit is saved. Then go to the next step.</p>
<p>4 Save an upper limit.</p> 	<p>The display first indicates [H. S E t.], and then the current upper limit blinks.</p> <p>Put a sample that provides an upper limit on the balance, and press the Function key.</p> <p>The upper limit is saved, and the balance goes back into measurement mode.</p>

* To set three or four points, repeat steps 3 through 4 above.

Saved limit values are displayed as [L 1 S E t] - [L 3 S E t] or [L 4 S E t] rather than [L. S E t] or [H. S E t]. In this case, a bar graph is displayed to indicate a rank.

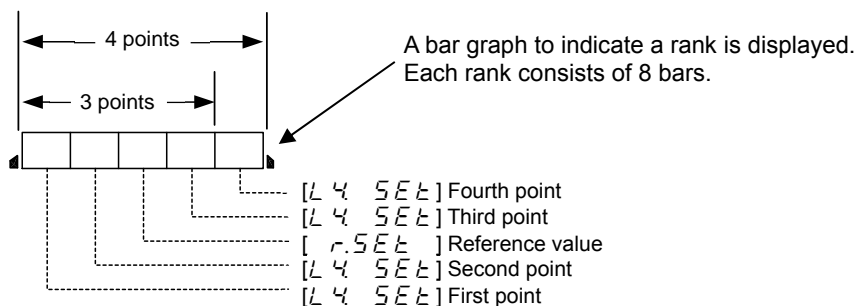

8.5.2 Set two limit values by entering values

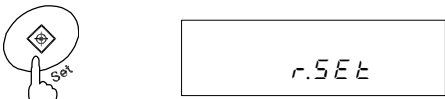
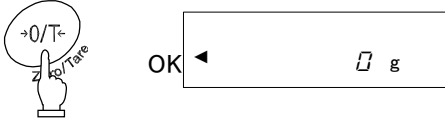
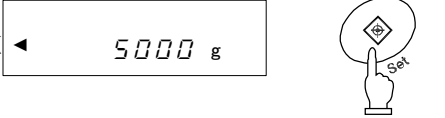
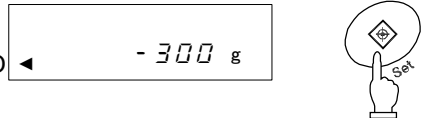
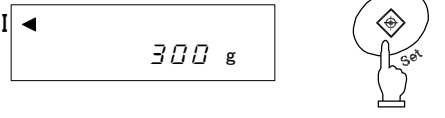
<p>1 Start the limit function.</p>  <p>Continuous press</p>	<p>Press the Set key for a few seconds.</p> <p>When a series of dots [<i>r.5 E t</i>] is displayed, release the key.</p> <p>The current reference weight blinks in the display.</p>
<p>2 Switch to the value input screen.</p> 	<p>Press the Zero/Tare key.</p> <p>A dot [<i>0</i>] blinks in the right end of the display.</p>
<p>3 Enter a reference weight.</p> 	<p>Repeat steps 3 and 4 in 8.4.2 to enter a reference weight.</p> <p>When you are entering a reference, the display indicates [OK ◀].</p> <p>When you enter a reference weight, press the Set key to save the value.</p>
<p>4 Save the lower limit.</p> 	<p>Repeat step 3 above to set a lower limit.</p> <div style="border: 1px solid black; padding: 5px; margin: 10px 0;"> <p>To judge by deviation values, enter a value with a minus sign (-) to specify a difference from a reference weight</p> </div> <p>(Refer to Caution 9 on page 32).</p> <p>When you enter an upper limit, press the Set key to save the value.</p> <p>(To set only one point, ignore the following step).</p>
<p>5 Save the upper limit.</p> 	<p>Set an upper limit in the same way as in step 4 above.</p> <p>When you enter an upper limit, press the Set key. The value is saved, and the balance goes back into measurement mode.</p>

You can use the **arrow** keys to enter values instead of the **Zero/Tare** key or the **Function** key (Refer to page 24).

* To set three or four points, repeat steps 2 through 5 above.

Saved limit values are displayed as [*L 1 S E t*] - [*L 3 S E t*] or [*L 4 S E t*] rather than [*L. S E t*] or [*H S E t*]. In this case, a bar graph is displayed to indicate a rank.

Caution:

1. The initial limit values are all zero.
2. You can set separate limit values for the weighing machine, parts counting, and percentage weighing functions. However, absolute values and deviation values are saved in the same storage area. So if you switch between absolute values and deviation values, limit values are deleted.
3. When the balance is not in measurement mode, you cannot set limit values by key operation. When a cumulative sum is being displayed, for example, you cannot set limit values.
4. Before you set limit values, adjust the zero point or set a tare range as required (You can adjust the zero point or set a tare range in sampling for parts counting or weight percent measuring).
5. You can check limit values by pressing the **Set** key.
The lower limit is displayed after the display indicates [*L. SEt*], and the upper limit is displayed after [*H. SEt*].
When you set three or four points, saved limit values are displayed as [*L 1 SEt*] - [*L 3 SEt*] or [*L 4 SEt*] rather than [*L. SEt*] or [*H. SEt*].
6. If you make an operation mistake in setting limit values when using actual samples, press the **Function** key. If you make an operation mistake in entering a limit value, press the **Set** key. The operation will be cancelled. Then start the operation from the beginning.
7. If you press the **Function** key when a value is blinking in the display, the weight of the sample on the balance is set as an actual sample weight. If you press the **Zero/Tare** key here, you can now enter a limit value.
8. When [**◀**] is displayed next to all of HI, OK, and LO, you have set a lower limit greater than the upper limit. You may have set only the upper limit with a minus sign. Set limit values again.
9. When you enter a limit value, it is treated differently between the two judgment methods.
To judge by absolute values, enter limit values directly. On the other hand, to judge by deviation values, you have to specify a range with respect to a reference weight.

(Example)

To set a lower limit of 970.0 g and an upper limit of 1050.0 g with respect to a reference weight of 1000.0 g, enter limit values as shown below:

	Reference Weight	Lower Limit	Upper Limit
Absolute weight	1000.0 g	970.0 g	1050.0 g
Judge by absolute values	1000.0 g	970.0 g	1050.0 g
Judge by deviation values	1000.0 g	-30.0 g	50.0 g



8.6 Bar Graph for the 2-point Scale

You can set two points for the limit function, and display a bar graph to indicate the result in a range specified by the two points.

All of the weighing machine, parts counting, and percentage weighing functions support this function.

<p>1 Set Function 1.</p> <div style="border: 1px solid black; padding: 5px; margin: 5px 0; width: fit-content;"> $23 P \cdot 2$ </div> <div style="border: 1px solid black; padding: 5px; margin: 5px 0; width: fit-content;"> $2R L G. 2$ </div>	<p>Set the 2-point scale [2] for Point Scale [$23 P \cdot 2$], and Bar graph for the 2-point scale [2] for How to Display Results [$2R L G.$] in Function 1.</p>
<p>2 Set upper and lower limits.</p>	<p>You can put actual samples on the balance or enter values to set upper and lower limits. You can also judge by absolute values or deviation values.</p>

A bar graph is displayed in one of the following ways:

Bar graph	Weight range	Description
	Lower limit > Weight	A bar graph is not displayed.
	Lower limit \leq Weight \leq Upper limit	A bar graph to indicate the judgment result is displayed.
	Weight > Upper limit	The whole bar graph is displayed.

Caution:

- When the lower limit is the same as the upper limit, a bar graph is not displayed.
- When a 2-point bar graph is being displayed, a normal bar graph to indicate the rate of a weight to the weighing capacity is not displayed.
- When a 2-point bar graph is being displayed, the limit function does not work.

☆ Hints ☆

The frame of the bar graph differs depending on whether the balance is in measurement mode, 3 or 4 points are set for the limit function, or it is a 2-point bar graph, as shown below:

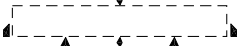
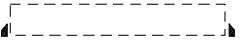
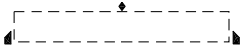
Bar graph frame	Balance condition
	Measurement mode Limit function (1- or 2-point scale)
	Limit function (3- or 4-point scale)
	2-point bar graph

9 Calibrating and Span Test for the Balance

Span Adjustment

An electronic balance, which is influenced by the acceleration of gravity, indicates different values depending on where it is used. For this reason, you should calibrate your balance every time you relocate it. You should also calibrate it after a long time of no use or when it does not indicate correct values.

To calibrate a balance is called span adjustment, which is required for highly accurate measurement.



Span Test

The span test is used to check the amount of offset in the span of the balance with respect to the reference weight. Performing this function will not calibrate the balance.

* To adjust the span or perform a span test, wait at least 30 minutes after the power is turned on.



9.1 Span Adjustment with Built-in Weight (Auto-span Adjustment)

* Only supported by the HJR-KCE series

<p>1 Set Function 1.</p> 	<p>Set Function 1 with nothing put on the pan. Select span adjustment with built-in weight (auto-span adjustment) in Function 1 [1 CR 1].</p>
<p>2 Start span adjustment.</p> 	<p>Press the Cal key.</p> <p>The built-in weight is enabled, and automatically starts span adjustment. The display indicates [Aut. CAL], [OK 0], [CHK F.S.], [buSY], and [End] in sequence. When span adjustment is completed, the balance goes back to the normal display.</p>

9.2 Span Adjustment with External Weight

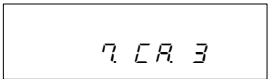
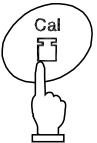
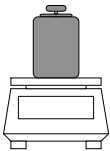
* This instrument cannot be used when it is sealed.

<p>1 Set Function 1.</p> 	<p>Set Function 1 with nothing put on the pan. Select span adjustment with external weight in Function 1 [1 CR 3].</p>
<p>2 Start span adjustment.</p>   	<p>Press the Cal key.</p> <p>The display first indicates [CAL EHL], and then [OK 0], and the balance starts adjusting the zero point (If the display indicates [PU SH F], press the Function key).</p> <p>When the display indicates [OK F.S.], put a weight on the pan. (If the display indicates [PU SH F], press the Function key).</p> <p>The balance starts adjusting the weighing capacity.</p> <p>The display indicates [buSY] and [End] in sequence. When span adjustment is completed, the balance goes back to the normal display.</p>

9.3 Span Test with Built-in Weight * Only supported by the HJR-KCE series

<p>1 Set Function 1.</p> <div style="border: 1px solid black; padding: 5px; width: fit-content; margin: 10px auto;"> $\bar{1}$ CR 2 </div>	<p>Set Function 1 with nothing put on the pan. Select span test with built-in weight in Function 1 [$\bar{1}$ CR 2].</p>
<p>2 Start a span test.</p> 	<p>Press the Cal key.</p> <p>The built-in weight is enabled, and automatically starts a span test.</p> <p>The display indicates [$\bar{1}$ INT], [$\bar{1}$ 0], [$\bar{1}$ F.S.], [$\bar{1}$ IFF], and an error in sequence. When you press a key, the balance goes back into measurement mode.</p>

9.4 Span Test with External Weight

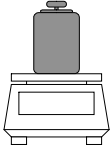
<p>1 Set Function 1.</p> <div style="border: 1px solid black; padding: 5px; width: fit-content; margin: 10px auto;"> $\bar{1}$ CR 4 </div>	<p>Set Function 1 with nothing put on the pan. Select span test with external weight in Function 1 [$\bar{1}$ CR 4].</p>
<p>2 Start a span test.</p>   <div style="border: 1px solid black; padding: 5px; width: fit-content; margin: 10px auto;"> $\bar{1}$ F.S. CAL </div>	<p>Press the Cal key.</p> <p>The display first indicates [$\bar{1}$ EXT], and then [$\bar{1}$ 0], and the balance starts testing the <u>zero point</u>. (If the display indicates [$\bar{1}$ PUSH F], press the Function key).</p> <p>When the display indicates [$\bar{1}$ F.S.], put a weight on the pan. (If the display indicates [$\bar{1}$ PUSH F], press the Function key).</p> <p>The balance starts a weighing capacity point test.</p> <p>The display first indicates [$\bar{1}$ IFF] and then an error.</p> <p>When you press a key, the balance goes back into measurement mode.</p>



*After [$\bar{1}$ IFF] is completed, the definition of a weight error is as follows:

$$\text{Weight error} = \text{True value} - \text{Current weight}$$

In other words, when a weight error is more than "0", the displayed weight is less than the actual weight.

9.5 Calibration of Built-in Weight * This instrument cannot be used when it is sealed.

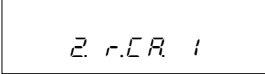
This function is only supported by the HJR-KCE series. This is a function to calibrate the built-in weight with an external weight.

<p>1 Set Function 2.</p> 	<p>Set Function 2 with nothing put on the pan. Enable the calibration of built-in weight function in Function 2 [2. r. ER 1].</p>
<p>2 Start span adjustment.</p> 	<p>Press the Function key. The display is changed [r EF. CAL].</p> <p>Press the Function key while holding down the Zero/Tare key, and release the keys at the same time. The display blinks [0.0 0], and then indicates [0.0 F.5].</p> <p>When the display indicates [0.0 F.5], put a weight on the pan carefully. (If the display indicates [PUSH F], press the Function key). The display blinks [0.0 F.5], and then indicates [0.0 0].</p> <p>When the display indicates [0.0 0], unload the weight. When calibration is completed, the display indicates [E n d], and the balance goes back to measurement mode.</p>

☆ Hints ☆

- When you press a **key other than the **Function** key** during span adjustment or a span test, the display indicates [S t o P], and the span adjustment or test is cancelled. Then the balance goes back to the normal display.
- To perform span adjustment or a span test with an external weight, use a weight for calibration that weighs 50 % of the weighing capacity or heavier. To calibrate more accurately, use a weight that is close to the weighing capacity.
Use a weight of OIML-E2 or a higher class to calibrate the built-in weight.
- When an error is found in span adjustment or in a span test, the following messages are displayed:
 - [1 - E r r]: You used a weight weighing less than 50% of the weighing capacity for span adjustment.
You used a weight weighing less than 95% of the weighing capacity to calibrate the built-in weight.
 - [2 - E r r]: An error over 1.0 % was detected in span adjustment with an external weight, or the balance failed.
 - [3 - E r r]: Automatic span adjustment was performed with an object put on the pan.
 - [4 - E r r]: An error over 1.0% was detected in automatic span adjustment, or the balance failed.
 - [7 - E r r]: Automatic span adjustment was stopped due to insufficient battery capacity.
 - [R - E r r]: Abnormal operation occurred in the internal driving unit during automatic span adjustment.



(Pressing a key when an error message is being displayed moves you back to measurement mode).

- * When one of these messages is displayed, calibration is not performed.
Check that you are using a proper weight, and start span adjustment or a span test again. If span adjustment with a proper weight results in the same error message, contact your local dealer.

10 Date and Time Setup

10.1 Time Setup

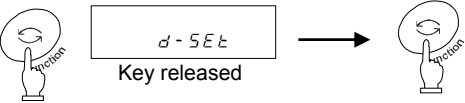
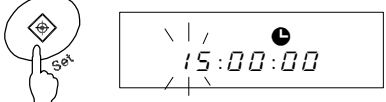
The time is displayed with a dot [●]. Set the time in Hour-Minute-Second format on a 24-hour basis.

<p>1 Display the time.</p>  <p>Continuous press</p>	<p>Press the Function key for a few seconds. When the display is changed from [F u n c] to [d - S E t], release the key. Press the Function key once. The display automatically indicates the time after indicating [t 1 1 E].</p>
<p>2 Set the time.</p> 	<p>Press the Set key. You can change a blinking digit. Use the Zero/Tare key to change the blinking digit. Use the Function key to blink the next digit to the right. If you press the Function key when the rightmost digit is blinking, the leftmost digit blinks.</p>
<p>3 Save the time.</p> 	<p>Press the Set key to save the settings. The changes are saved, and a date is displayed.</p>

When you press the **Print** key before saving a time, the original time is displayed.



30-sec adjustment function

Press the **Zero/Tare** key when the time is being displayed.

29 or fewer seconds are rounded down to the nearest minute, and 30 or more seconds are rounded up to the nearest minute.

10.2 Date Setup

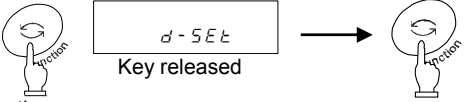
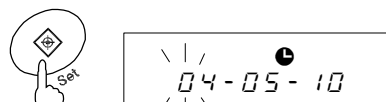
A date is displayed with a dot [●]. The last two digits of the year are displayed. You can change the date format in Function 1.

<p>1 Display the date.</p>  <p>Continuous press</p>	<p>Follow step 1 in 10.1 to change the display to [d - S E t] (Go straight to step 2 if you set a date after completing steps in 9.1). Press the Function key twice. The display automatically indicates a date after indicating [t 1 1 E].</p>
<p>2 Set a date.</p> 	<p>Press the Set key. You can change a blinking digit. Use the Zero/Tare key to change the blinking digit. Use the Function key to blink the next digit to the right. If you press the Function key when the rightmost digit is blinking, the leftmost digit blinks.</p>
<p>3 Save the date.</p> 	<p>Press the Set key to save the settings. The changes are saved, and the balance goes back into measurement mode.</p>

When you press the **Print** key before saving a date, the original date is displayed.

11 Various Functions

11.1 Auto Sleep Function

This is a function to turn off the display when the balance is left to stand in measurement mode for about 3 minutes. This function can only be used when the balance is operated on the AC adapter. To use the auto sleep function, enable it in Function 1 [*R* *R.S.* *1*].

When the auto sleep function is enabled, the Sleep lamp (LED) lights up.

To exit sleep mode, touch the pan or press a key.

Caution:

The auto sleep function does not work under the following conditions:

1. You are setting Function 1, Function 2, a time or date, or the interval function.
2. An object is put on the pan, and the display is not stable.
3. The balance is operated on batteries.

11.2 Auto Power Off Function

This is a function to turn off the balance when the balance is left to stand in measurement mode for about 3 minutes. This function can only be used when the balance is operated on batteries. This function saves battery capacity.

To use the this function, enable it in Function 1 [*9* *AP.* *1*].

Caution:

The auto power off function does not work under the following conditions:

1. You are setting Function 1, Function 2, a time or date, or the interval function.
2. An object is put on the pan, and the display is not stable.
3. The balance is operated on the AC adapter.

11.3 Set Unit Function

This is a function to allow you to select two units (unit A and unit B) and switch between the units.

Which unit to display can be set in Function 1. You can also set the same unit for unit A and unit B.

Pressing the Function key switches the unit between unit A and unit B.

Caution:

To use unit B, select the weighing machine function in Function 1 [*1* *SET* *1*]. Unit A can be used in all modes.

11.4 Double Range Function

Only HJR-62KD[S]E and HJ-62KD[S]E support the double range function. This is a function to switch the minimum readability between 0.1 g and 1 g. A minimum readability of 0.1 g is used for a gross weight of 6200.9 g or lighter, and a minimum readability of 1 g is used for a gross weight of 6201 g or heavier.

To use the double range function, enable it in Function 1 [\overline{L} *d.r* *1*].

11.5 Date Display

This is a function to set the date format to be displayed in the balance or output to a printer. Set date format in Function 1 appropriately as shown below:

Date Display	<i>F. DATE</i>	<i>1</i>	Output in Year-Month-Day format.
		<i>2</i>	Output in Month-Day-Year format.
		<i>☆3</i>	Output in Day-Month-Year format.

11.6 Time Stamp Output

This is a function to output measurement data with the current time. You should set the time before this function is used.

To use this function, enable it in Function 1 [\overline{L} *t.o* *1*].



11.7 Direct Start Function

This is a function to turn on the balance automatically when it is connected to the AC power. You can use this function when the balance is used in conjunction with other devices. To use this function, enable it in Function 1 [\overline{L} *d.st* *1*].

11.8 Interval Output Function

This is a function to output data at intervals. You can also output data with the current time. Set an interval in Hour-Minute-Second format. To use the interval output function, enable it in Function 1 [[5 t o.c. R]] or [[5 t o.c. b]].

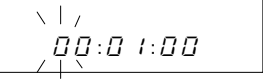
11.8.1 Set interval output

<p>1 Call the interval function.</p>  <p>Continuous press</p>	<p>Press the Set key until the display indicates a series of dots [t n t. U R L]. The display indicates an interval with the leftmost digit blinking.</p>
<p>2 Set an interval.</p> 	<p>Press the Zero/Tare key to change the blinking value, and the Function key to blink the next digit to the right. If you press the Function key when the rightmost digit is blinking, the leftmost digit blinks. (You can use the arrow keys instead. Refer to page 24).</p>
<p>3 Save the settings, and go back to measurement mode.</p> 	<p>Press the Set key to return to measurement mode.</p> <p>When you press the Print key before saving an interval, the original interval is displayed. If you press a key other than the Set key here, the balance goes back to measurement mode, but the settings are not saved.</p>

11.8.2 Start interval output

Press the **Print** key. The display indicates a series of dots [[5 t R r t]], and starts interval output. A dot [[●]] blinks during interval output. A dot [[☐]] lights up when data is output.

11.8.3 Stop interval output

Press the **Print** key. The display indicates [[E n d]], and the balance goes back to measurement mode.

Caution:

1. Data may not be output at exact intervals because output is stopped when Function 1 or Function 2 is displayed.
2. A series of dots [[5 - E r r]] may be displayed when you set an interval. This indicates that the interval is too short. In this case, you should set an interval again.



11.9 Enter an ID Number

An ID number is used when data is printed in compliance with ISO/GLP/GMP. Set an ID number when you print data.

When an ID number is displayed, a dot [◀] and a triangle [▲] are displayed in the upper left of the display.

You can use up to 6 digits in an ID number. You can use [0-9], [A-F], and [-], which are displayed in this order. An underscore [_] indicates a blank space.

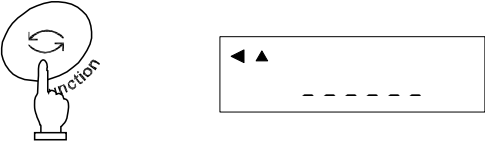
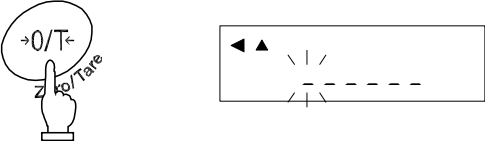
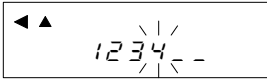
11.9.1 Set an ID number

<p>1 Set Function 2.</p> 	<p>Enable Setup of ID No. in Function 2 [f id i].</p>
<p>2 Display an ID number.</p> 	<p>Press the Function key. An ID number is displayed.</p> <p>If you want to check the ID number, press the Function key again. The display is changed [2. r.C R 0].</p>
<p>3 Start to enter an ID number.</p> 	<p>Press the Zero/Tare key. You can now enter an ID number.</p> <p>The leftmost digit blinks first.</p>
<p>4 Enter an ID number.</p> 	<p>Press the Zero/Tare key to change the blinking value, and the Function key to blink the next digit to the right. If you press the Function key when the rightmost digit is blinking, the leftmost digit blinks. (You can use the arrow keys instead. Refer to page 24).</p>
<p>5 Save the ID number.</p> 	<p>Press the Set key. The setting is saved, and the display is changed [2. r.C R 0].</p> <p>When you press the Print key before saving an ID number, the original ID number is displayed.</p>

12. Input/Output Functions

12.1 RS232C Output

12.1.1 Connector pin numbers and functions

Pin No.	Signal Name	Input/Output	Function & Remarks
1	-	-	-
2	RXD	Input	Receiving data
3	TXD	Output	Transmitting data
4	DTR	Output	HIGH (When the balance is powered ON)
5	GND	-	Signal ground
6	-	-	-
7	-	-	-
8	-	-	-
9	-	-	-

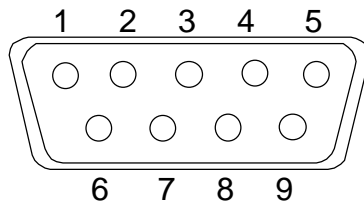

D-SUB9P Male Connector: Rear Panel

Caution:

Be sure to disconnect the AC adapter from the power outlet before plugging or unplugging the connector.

12.1.2 Connection between the balance and a PC

■■■ Sample wire connection with an IBM-PC/AT compatible machine ■■■

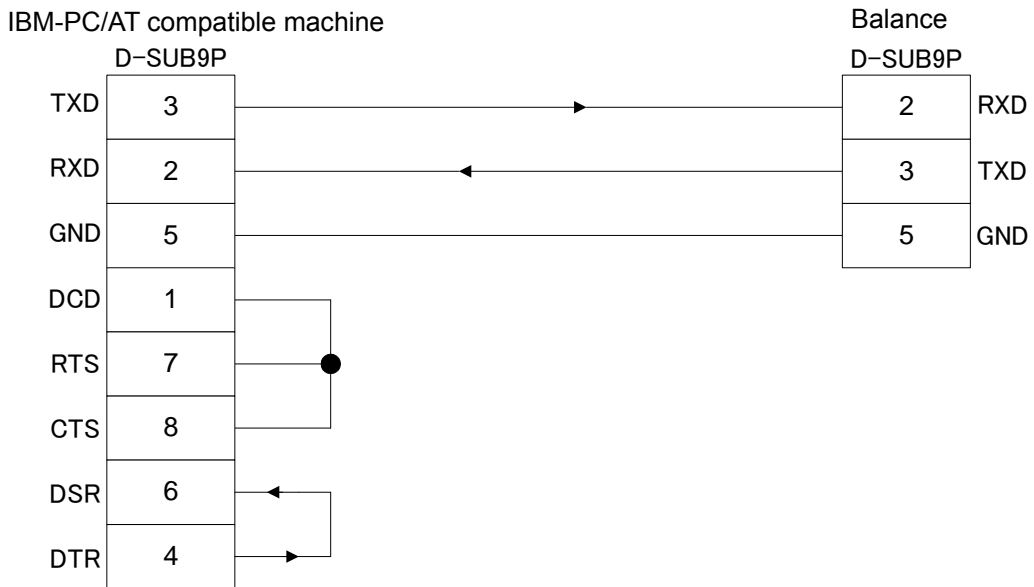

■■■ Sample wire connection with PC9801 ■■■

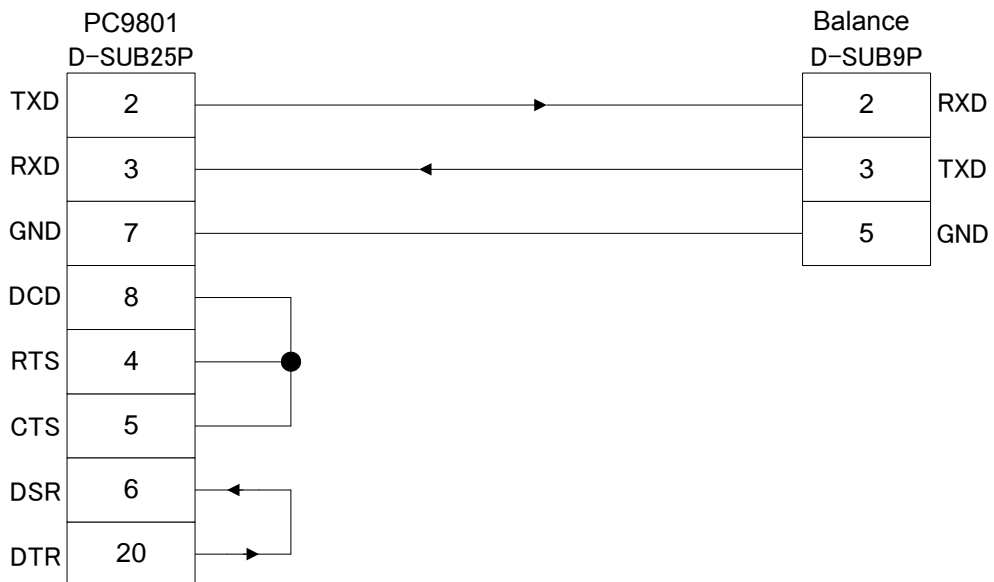

12.1.3 Interface specifications

- (1) Transmission system Serial transmission. Start-stop synchronization.
- (2) Transmission rate 1200/2400/4800/9600/19200 bps
- (3) Transmission codes ASCII codes (8/7 bits)
- (4) Signal level Compliant with EIA RS-232C.
 HIGH level (data logic 0) +5 – +15 V
 Low level (data logic 1) -5 – -15 V
- (5) Bit configuration Start bit 1 bit
 Data bits 8/7 bits
 (7 bits can be specified for extended 7-digit numeric format.)
 Parity bit 0/1 bit
 Stop bits 2/1 bit
 (1 bit can be specified for extended 7-digit numeric format.)
- (6) Parity bit None/Odd/Even

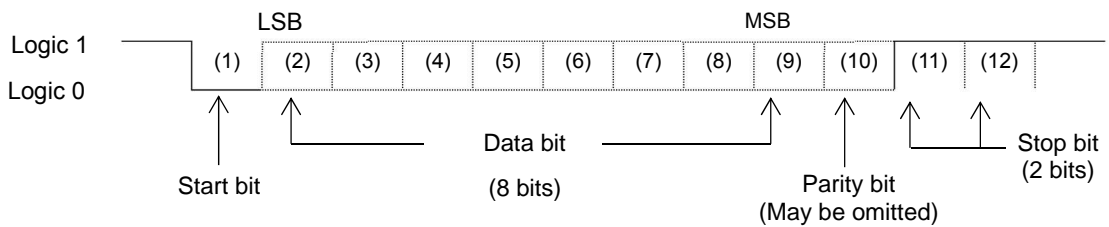

12.2 Output to Peripherals

Our standard peripheral units can be connected to the balance.*1

These peripheral units include: CSP-160, CSP-240

12.2.1 Connector pin numbers and functions

Pin No.	Signal Name	Input/Output	Function & Remarks
1	EXT.TARE	Input	Tare setting from an external device *2
2	-	-	-
3	-	-	-
4	TXD	Output	Transmitting data
5	GND	-	Signal ground
6	-	-	-
7	-	-	-
8	-	-	-

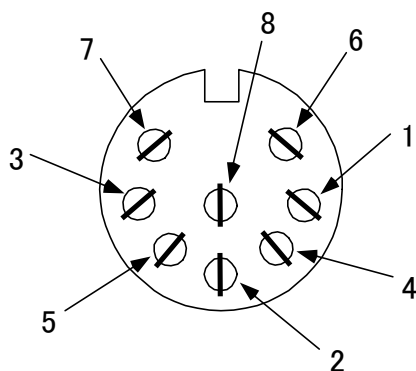

DIN8P connector for output to peripheral devices

*1 To connect a peripheral unit to the balance, use a connection cable supplied with the unit.

*2 You can set a tare range or adjust the zero point from an external device by connecting a contact or a transistor switch between pin 1 and pin 5. In this case, allow at least 400 ms for connection (ON) time (Maximum voltage when the balance is turned OFF: 15 V, sink current when it is turned ON: 20 mA).

Caution:

Be sure to disconnect the AC adapter from the power outlet before plugging or unplugging the connector.

12.3 Type of Communication Texts

This interface function uses the following three types of communication texts:

- (1) Output data Data, such as weight values, that is output from the balance to an external unit
- (2) Input commands Commands to control the balance from an external unit
- (3) Response Response that is output from the balance to an input command

Caution:

1. All of these communication texts can be used for RS232C output.
2. Only output data (1) can be used for a peripheral output unit.

12.4 Output Data

You can select one from the following three formats in Function 1:

12.4.1 Data format

(1) 6-digit numeric format

Consists of 14 characters including terminators (CR=0DH, LF=0AH).

1	2	3	4	5	6	7	8	9	10	11	12	13	14
P1	D1	D2	D3	D4	D5	D6	D7	U1	U2	S1	S2	CR	LF

(2) 7-digit numeric format

Consists of 15 characters including terminators (CR=0DH, LF=0AH). A parity bit can be appended.

1	2	3	4	5	6	7	8	9	10	11	12	13	14	15
P1	D1	D2	D3	D4	D5	D6	D7	D8	U1	U2	S1	S2	CR	LF

(3) Extended 7-digit numeric format

Consists of 15 characters including terminators (CR, LF). A parity bit can be appended.

This is an extended version of the 7-digit numeric format. The extended version is different from the 7-digit numeric format in that:

- the data length can be 7 bits rather than 8 bits, and
- the stop bit length can be 1 bit rather than 2 bits.

The extended version is the same as the normal 7-digit format in other bits. However, if you select Japanese (Katakana) for Printed Language [*E 3 P.F.*] in Function 1, the data length is forced into 8 bits.

(4) Format with 6-digit value with auxiliary scale interval that is compatible with type approval

This format is composed of 15 characters, including the terminators (CR=0DH, LF=0AH). A slash “/” is inserted before the auxiliary scale interval.

While the format with 6-digit value is selected, the auxiliary scale is output in this format.

1	2	3	4	5	6	7	8	9	10	11	12	13	14	15	
P1	D1	D2	D3	D4	D5	D6	D7	D8	U1	U2	S1	S2	CR	LF	

(5) Format with 7-digit value with auxiliary scale interval that is compatible with type approval

This format is composed of 16 characters, including the terminators (CR=0DH, LF=0AH). A parity bit can be added. A slash “/” is inserted before the auxiliary scale interval.

While the format with 7-digit value is selected, the auxiliary scale is output in this format.

1	2	3	4	5	6	7	8	9	10	11	12	13	14	15	16
P1	D1	D2	D3	D4	D5	D6	D7	D8	D9	U1	U2	S1	S2	CR	LF

(6) Extended format with 7-digit value with auxiliary scale interval that is compatible with type approval

This format is composed of 16 characters, including the terminators (CR=0DH, LF=0AH). A parity bit can be added. A slash “/” is inserted before the auxiliary scale interval.

While the extended format with 7-digit value is selected, the auxiliary scale is output in this format. The settings for data length and stop bit are the same as those for the extended format with 7-digit value.

1	2	3	4	5	6	7	8	9	10	11	12	13	14	15	16
P1	D1	D2	D3	D4	D5	D6	D7	D8	D9	U1	U2	S1	S2	CR	LF

12.4.2 Polarity (P1: 1 character)

P1	Code	Description
+	2BH	When data is 0 or positive.
-	2DH	When data is negative.

12.4.3 Numeric data

6-digit numeric format: (D1-D7: 7 characters)
 7-digit numeric format: (D1-D8: 8 characters)
 Extended format with 7-digit value: (D1-D8: 8 characters)
 Format with 6-digit value with auxiliary scale interval: (D1-D8: 8 characters)
 Format with 7-digit value with auxiliary scale interval: (D1-D9: 9 characters)
 Extended format with 7-digit value with auxiliary scale interval: (D1-D9: 9 characters)

D1 – D7, D8, D9	Code	Description
0 – 9	30H – 39H	Digits 0 – 9
•	2EH	* Decimal point (floating) * Data in integer are omitted, and SP is output in the lowest digit.
SP (space)	20H	* Space heading a numeric value * When numeric data does not contain decimal places, space rather than a decimal point is output to the least significant digit *1.
/	2FH	This sign is inserted before the auxiliary scale interval in the Format with an auxiliary scale interval that is compatible with type approval.

*1 A numeric value is headed by 0 (30H) by factory default setting. You can change the function setting so that it is headed by space (20H) rather than 0.

* When the twin range/double range function of the instrument is used, SP is output in the lower digits, which correspond to the blanks in the displayed lower digits.

12.4.4 Unit (U1, U2: 2 characters)

* Codes are all ASCII codes.

U1	U2	Code		Meaning	Balance indicators
(SP)	G	20H	47H	gram	g
K	G	4BH	47H	kilogram	kg
C	T	43H	54H	carat	ct
P	C	50H	43H	Pieces	Pcs
(SP)	%	50H	25H	Percentage	%

12.4.5 Judgment result when the limit function is enabled (S1: 1 character)

S1	Code	Description	
L	4CH	Too little (LO)	1- or 2-point scale
G	47H	Proper (OK)	
H	48H	Too much (HI)	
1	31H	Rank 1	3- or 4-point scale
2	32H	Rank 2	
3	33H	Rank 3	
4	34H	Rank 4	
5	35H	Rank 5	
T	54H	Cumulative value	Data type
U	55H	Unit weight	
(SP)	20H	No judgment result or no data type specified	
d	64H	Gross	

12.4.6 Status (S2:1 character)

S2	Code	Description
S	53H	Data stable *
U	55H	Data unstable *
E	45H	Data error (Indicates that data other than S2 is invalid.) ([ρ - Err], [μ - Err])
(SP)	20H	No status specified

* Data that is independent of whether the weighing condition is stable or not, such as cumulative values and unit weights, is independent of whether S2 is S or U when it is output.

12.4.7 Output data other than measurement data

(1) Interval output

When interval output is started or stopped, a header and a footer are output.

Header

- is output for 15 characters.

1	2	3	4	5	6	7	8	9	10	11	12	13	14	15
-	-	-	-	-	-	-	-	-	-	-	-	-	-	-

Footer

Two linefeeds are inserted.

(2) Time output

When the time stamp function is enabled, the time is output one line above output data.

1	2	3	4	5	6	7	8
h	h	:	m	m	:	s	s

* hh: hour (00-23), mm: minute (00-59), ss: second (00-59)

12.5 Input Commands

The following 7 input commands are supported:

- | | |
|----------------------------------|---------------------------------|
| (1) Tare range command | (2) Set output control command |
| (3) Set measurement mode command | (4) Request date output command |
| (5) Request time output command | (6) Set interval command |
| (7) Span adjustment/test command | |

12.5.1 Procedure for transmission

- (1) Send an input command from an external device.

The full-duplex transmission system allows you to send an input command anytime independently of when the balance sends data.

- (2) When the balance executes a received command successfully, it sends back a response to indicate successful completion of the command, or data requested by the input command. When it fails to execute a command successfully, or receives an invalid input command, it sends back an error response.

When the balance is in normal display mode, it usually sends a response to an input command in one second after it is transmitted.

However, if the balance receives a tare range command when the Set Tare function is set so that the display is reset to 0 when the balance is stabilized after the Zero/Tare key is pressed, or if it receives an input command that takes a long time, it sends a response after the command is completely processed.

If the balance receives an input command when you are setting a function, when it is under span adjustment, or it is busy for other reasons, it sends a response after that operation is completed.

- 1) Commands to which a response is sent back after a specified operation is executed
 - Tare range command, span adjustment/test command
- 2) Commands to which a response is sent back immediately or in 1 second after they are received
 - Commands other than those specified in 1) above
- (3) Once you send an input command from an external device, do not send another input command to the balance until the external device receives a response to the command from the balance.

12.5.2 Response

You can select the response format from A00/Exx format and ACK/NAK format in Function 1.

(1) A00/Exx format

Consists of 5 characters including terminators (CR, LF).

1	2	3	4	5
A1	A2	A3	CR	LF

Response types

A1	A2	A3	Code			Meaning
A	0	0	41H	30H	30H	Successful completion
E	0	1	45H	30H	31H	* Command error (when an errant command is received)
E	0 - 9	0 - 9	45H	30H 5 39H	30H 5 39H	(Errors other than E01) * Numeric format error * Processing interrupted * Processing terminated abnormally * Other errors

(2) ACK/NAK format

Consists of 1 character (Does not contain a terminator).

1
A1

Response types

A1	Code	Meaning
ACK	06H	Successful completion
NAK	15H	* Command error (when an errant command is received) * Numeric format error * Processing interrupted * Processing terminated abnormally * Other errors

* The following descriptions and tables assume that the A00/Exx format is selected for response format.

Think of A00 as ACK, and E00 as NAK.

12.5.3 Command format

(1) Tare range (zero-setting) command

C1	C2	Code		Description	Value	Response
T	(SP)	54H	20H	<ul style="list-style-type: none"> Set Tare Range Adjust the zero point 	None	A00: Successful completion E01: Command error E04: A tare range cannot be set or the zero point cannot be adjusted (because of a range violation or a weight error).

(2) Set output control command

C1	C2	Code		Description	
0	0	4FH	30H	Stop output	A00: Successful completion E01: Command error E02: Interval time error (OA or OB only)
0	1	4FH	31H	Output continuously at all times	
0	2	4FH	32H	Output continuously if stable (Stop output if unstable)	
0	3	4FH	33H	Output once when the Print key is pressed (whether the balance is stable or unstable).	
0	4	4FH	34H	Output once when the balance is stable. Output when a substance is lifted to cause the display to indicate a value below 0, and then another substance is put on to make the balance stable.	
0	5	4FH	35H	Output once when the balance is stable. Stop output when unstable. Output once when the balance is stabilized again even if it is not reloaded (the output includes zero).	
0	6	4FH	36H	Output once when the balance is stable. Output continuously when unstable. Output is stopped after a single output when the balance is stable even if it is not reloaded.	
0	7	4FH	37H	Output once when Print key is pressed if the balance is stable.	
0	8	4FH	38H	Output once immediately	
0	9	4FH	39H	Output once after stabilizing	
0	A	4FH	41H	Interval function (Output once every time the output time elapses)	
0	B	4FH	42H	Interval function (Output once if stable every time the output time elapses)	

- * Commands O0 to O7 control output in the same way as the settings in Function 1.
- * Commands O8 and O9 are used to request data from the balance.
- * Once executed, O0 to O7, OA, or OB is held until the next command is input. However, output control is reset to the function setting when the balance is turned on again.
- * When command OA or OB is input, the balance initiates the interval function, and when the same command is input again, it terminates the function.

12.5.4 Set measurement mode command

Command Main Body				Description	Value	Response
1st character	2nd character	Code				
M	1	4DH	31H	Mode 1	None	A00: Successful completion E01: Command error E02: (error)
M	2	4DH	32H	Mode 2		
M	3	4DH	33H	Mode 3		
M	4	4DH	34H	Mode 4		

* Measurement mode depends on the combination of the Weighing Mode and which mode is specified (mode 1, 2, 3, or 4).

Description	Weighing machine	Parts counting	Percentage weighing
Mode 1	Weight measuring	Weight measuring	Weight measuring
Mode 2	Gross weight	Parts counting	Percent measuring
Mode 3	Cumulative weight *1	Cumulative count display *1	Cumulative percent display *1
Mode 4	Unit B *2	Average unit weight	(Error)

*1 Mode 3 (M3) can be specified only when the Addition function is enabled. If the Addition function is not enabled, an error is returned.

*2 If a unit is not specified for unit B, the balance enters weight measuring mode. When you specify a mode that is not supported by the current Weighing Mode, an error is returned from the balance.

12.5.5 Request date or time output command

Command Main Body				Description	Value	Response
1st character	2nd character	Code				
D	D	44H	44H	Date output request	None	A00: Successful completion E01: Command error
D	T	44H	54H	Time output request		

(1) Date format *2

DATE:yyyy.mm.dd(CR)(LF)

English

ヒツ ㇿ:yyyy.mm.dd(CR)(LF)

Japanese (Katakana)

(2) Time data

TIME:(SP)(SP)(SP)(SP)(SP)hh:mm(CR)(LF)

English

シ ｺㇿ:(SP)(SP)(SP)(SP)(SP)hh:mm(CR)(LF)

Japanese (Katakana)

The above data is accompanied by a control command of our printer when output.

*1 You can select whether you want to output data in English or in Japanese (katakana) in Printed Language of Function 1 [E 3 P.F.].

*2 Date format depends on the setting of Date Display in Function 1 [F. dRtE].

12.5.6 Setting intervals

Command Main Body				Description	Value	Response
1st character	2nd character	Code				
I	A	49H	41H	Interval time setup	Interval time	A00: Successful completion E01: Command error E02: Interval time error

* Upon setting the time interval, mark off between the entries of command, hour, minute, and second using a comma, "," between each of the entries; e.g., IA, hh, mm, ss.

12.5.7 Span adjustment/test command

Command Main Body				Description	Value	Response
1st character	2nd character	Code				
C	0	43H	30H	Disable the Cal key. *1	None	A00: Successful completion E01: Command error E02: Operation is disabled. E03: Cancelled by operation E04: Abnormal completion
C	1	43H	31H	Span adjustment with built-in weight (Auto-span adjustment)		
C	2	43H	32H	Span test with built-in weight		
C	3	43H	33H	Span adjustment with external weight		
C	4	43H	34H	Span test with built-in weight		

* This command takes time because the balance sends back a response after an appropriate operation is completed.

* If the Cal key is disabled in Span Adjustment/Span Test of Function 1 [7 [R], a span adjustment/test command does not work.

* If the Cal key is disabled, however, the setting is reset to the function setting when the balance is turned on again.

12.5.8 Sample input commands

T(SP)(CR)(LF)	Set a tare weight or adjust the zero point.
O1(CR)(LF)	Set the balance to continuous output.
O8(CR)(LF)	Output data (once immediately).
IA,12,34,56(CR)(LF)	Set an interval of 12 hrs. 34 min. 56 sec.
OA(CR)(LF)	Start the interval function.
DD(CR)(LF)	Output the date.
DT(CR)(LF)	Output the time.
C1(CR)(LF)	Execute span adjustment with the built-in weight.

13 Use Printers

13.1 Setting up the Printer

- (1) Use CSP-160 or CSP-240 with the balance.
- (2) Set proper print functions (print control) with the balance referring to the instruction manual for your printer.
The factory default of our printer is manual printing (printer control).
- (3) Make the baud rate and other settings compatible between the balance and the printer.

13.2 Saving CAL and span test results

<p>1 Set Function 1.</p> <div style="display: flex; justify-content: space-around;"> <div style="border: 1px solid black; padding: 5px; width: 100px; text-align: center;">E GLP 1</div> <div style="border: 1px solid black; padding: 5px; width: 100px; text-align: center;">E t out 1</div> </div>	<p>Set the ISO/GLP/GMP compatible item to [E GLP 1] and set the GLP compatible item for measurement data to [E t out 1].</p>
<p>2 Performs span adjustment/span test.</p> <div style="border: 1px solid black; padding: 5px; width: 150px; text-align: center;"> busy </div>	<p>During output, it indicates [busy >] and it looks like the balance is frozen. However, this is a normal operation. Wait until the output operation is completed.</p>

13.3 Output of Measurement Data in Compliance with ISO/GLP/GMP

<p>1 Set Function 1.</p> <div style="display: flex; justify-content: space-around;"> <div style="border: 1px solid black; padding: 5px; width: 100px; text-align: center;">E GLP 1</div> <div style="border: 1px solid black; padding: 5px; width: 100px; text-align: center;">E2. od 1</div> </div>	<p>Set the ISO/GLP/GMP compatible item to [E GLP 1] and set the GLP compatible item for measurement data to [E2. od 1].</p>
<p>2 Header output</p> <div style="display: flex; align-items: center;"> <div style="border: 1px solid black; padding: 5px; width: 150px; text-align: center;"> HEAd </div> </div> <p>Continuous press</p>	<p>Press and hold the Print key for a while.</p> <p>The display indicates [HEAd] and a header is output.</p>
<p>3 Measurement data output</p>	<p>Measurement data can be output at any time during measurements.</p>
<p>4 Footer output</p> <div style="display: flex; align-items: center;"> <div style="border: 1px solid black; padding: 5px; width: 150px; text-align: center;"> Foot </div> </div> <p>Continuous press</p>	<p>Press and hold the Print key for a while after the measurement is completed.</p> <p>The display indicates [Foot] and a footer is output.</p>

Caution

- (1) Upon printing calibration/span test results or ISO/GLP/GMP compatible outputs, date and time data is also printed.
Check the date and time set in the balance before printing. (Refer to Section 10: Date and Time Setup in page 40).
 - (2) Do not press any keys on the printer during printing.
- * Refer to Section 14 "Output in Compliance with ISO/GLP/GMP" described from page 56 for sample prints.

14 Output in Compliance with ISO/GLP/GMP

When span adjustment or a span test with the built-in weight or an external weight is completed, the results are printed. If span adjustment or a span test is not completed successfully, no data is printed. X in the following tables represents a certain character.

(1) Span adjustment with the built-in weight (auto-span adjustment)

English

1															
2	*	*	C	A	L	I	B	R	A	T	I	O	N	*	*
3															
4	D	A	T	E	:	2	0	0	3	.	0	6	.	2	6
5	T	I	M	E	:						1	6	:	5	6
6		S	H	I	N	K	O		D	E	N	S	H	I	
7	T	Y	P	E	:										
8	X	X	X	X	X	X	H	J	R	-	1	7	K	C	E
9	S	/	N	:		X	X	X	X	X	X	X	X	X	X
10	I	D	:						X	X	X	X	X	X	X
11															
12	C	A	L	.	I	N	T	E	R	N	A	L			
13	R	E	F	:											
14			X	X	X	X	X	X	X	X	X	X	X		g
15															
16	C	O	M	P	L	E	T	E							
17	D	A	T	E	:	2	0	0	3	.	0	6	.	2	6
18	T	I	M	E	:						1	6	:	5	7
19															
20	S	I	G	N	A	T	U	R	E						
21															
22															
23															
24	*	*	*	*	*	*	*	*	*	*	*	*	*	*	*
25															
26															
27															
28															

Japanese (Katakana)

1																
2	*	*	*					コ	ウ	セ	イ			*	*	*
3																
4	ヒ	ツ	"	ケ	:	2	0	0	3	.	0	6	.	2	6	
5	シ	"	コ	ク	:						1	6	:	5	6	
6		S	H	I	N	K	O		D	E	N	S	H	I		
7	カ	タ	シ	キ	:											
8	X	X	X	X	X	X	H	J	R	-	1	7	K	C	E	
9	セ	イ	ハ	"	ン	X	X	X	X	X	X	X	X	X	X	
10	I	D	:						X	X	X	X	X	X	X	
11																
12	コ	ウ	セ	イ	(ナ	イ	フ	"	フ	ン	ト	"	ウ)	
13	キ	シ	"	ユ	ン	:										
14			X	X	X	X	X	X	X	X	X	X	X		g	
15																
16	シ	ユ	ウ	リ	ヨ	ウ										
17	ヒ	ツ	"	ケ	:	2	0	0	3	.	0	6	.	2	6	
18	シ	"	コ	ク	:						1	6	:	5	7	
19																
20	シ	ヨ	メ	イ												
21																
22																
23																
24	*	*	*	*	*	*	*	*	*	*	*	*	*	*	*	
25																
26																
27																
28																

(2) Span adjustment with an external weight

English

1															
2	*	*	C	A	L	I	B	R	A	T	I	O	N	*	*
3															
4	D	A	T	E	:	2	0	0	3	.	0	6	.	2	6
5	T	I	M	E	:						1	6	:	5	5
6		S	H	I	N	K	O		D	E	N	S	H	I	
7	T	Y	P	E	:										
8	X	X	X	X	X	X	H	J	R	-	1	7	K	C	E
9	S	/	N	:		X	X	X	X	X	X	X	X	X	X
10	I	D	:						X	X	X	X	X	X	X
11															
12	C	A	L	.	E	X	T	E	R	N	A	L			
13	R	E	F	:											
14			X	X	X	X	X	X	X	X	X	X	X		g
15															
16	C	O	M	P	L	E	T	E							
17	D	A	T	E	:	2	0	0	3	.	0	6	.	2	6
18	T	I	M	E	:						1	6	.	5	6
19															
20	S	I	G	N	A	T	U	R	E						
21															
22															
23															
24	*	*	*	*	*	*	*	*	*	*	*	*	*	*	*
25															
26															
27															
28															

Japanese (Katakana)

1																
2	*	*	*					コ	ウ	セ	イ			*	*	*
3																
4	ヒ	ツ	"	ケ	:	2	0	0	3	.	0	6	.	2	6	
5	シ	"	コ	ク	:						1	6	:	5	6	
6		S	H	I	N	K	O		D	E	N	S	H	I		
7	カ	タ	シ	キ	:											
8	X	X	X	X	X	X	H	J	R	-	1	7	K	C	E	
9	セ	イ	ハ	"	ン	X	X	X	X	X	X	X	X	X	X	
10	I	D	:						X	X	X	X	X	X	X	
11																
12	コ	ウ	セ	イ	(カ	"	イ	フ	"	フ	ン	ト	"	ウ	
13	キ	シ	"	ユ	ン	:										
14			X	X	X	X	X	X	X	X	X	X	X		g	
15																
16	シ	ユ	ウ	リ	ヨ	ウ										
17	ヒ	ツ	"	ケ	:	2	0	0	3	.	0	6	.	2	6	
18	シ	"	コ	ク	:						1	6	:	5	7	
19																
20	シ	ヨ	メ	イ												
21																
22																
23																
24	*	*	*	*	*	*	*	*	*	*	*	*	*	*	*	
25																
26																
27																
28																

(3) Span test with the built-in weight

English

1															
2	*	*	C	A	L	.	T	E	S	T	*	*	*	*	*
3															
4	D	A	T	E	:	2	0	0	3	.	0	6	.	2	6
5	T	I	M	E	:						1	6	:	5	6
6	S	H	I	N	K	O				D	E	N	S	H	I
7	T	Y	P	E	:										
8	X	X	X	X	X	X	H	J	R	-	1	7	K	C	E
9	S	/	N	:		X	X	X	X	X	X	X	X	X	X
10	I	D	:						X	X	X	X	X	X	X
11															
12	C	A	L	.	I	N	T	.	T	E	S	T			
13	R	E	F	:											
14			X	X	X	X	X	X	X	X	X	X	X		g
15	D	I	F	F	:										
16			X	X	X	X	X	X	X	X	X	X	X		g
17															
18	C	O	M	P	L	E	T	E							
19	D	A	T	E	:	2	0	0	3	.	0	6	.	2	6
20	T	I	M	E	:						1	6	:	5	7
21															
22	S	I	G	N	A	T	U	R	E						
23															
24															
25															
26	*	*	*	*	*	*	*	*	*	*	*	*	*	*	*
27															
28															
29															
30															

Japanese (Katakana)

1																
2	*	*	*						テ	ス	ト			*	*	*
3																
4	ヒ	ツ	"	ケ	:	2	0	0	3	.	0	6	.	2	6	
5	シ	"	コ	ク	:						1	6	:	5	6	
6	S	H	I	N	K	O				D	E	N	S	H	I	
7	カ	タ	シ	キ	:											
8	X	X	X	X	X	X	H	J	R	-	1	7	K	C	E	
9	セ	イ	ハ	"	ン	X	X	X	X	X	X	X	X	X	X	
10	I	D	:							X	X	X	X	X	X	
11																
12	テ	ス	ト	(ナ	イ	フ	"	フ	ン	ト	"	ウ)		
13	キ	シ	"	ユ	ン	:										
14			X	X	X	X	X	X	X	X	X	X	X		g	
15	コ	"	サ	:												
16			X	X	X	X	X	X	X	X	X	X	X		g	
17																
18	シ	ユ	ウ	リ	ヨ	ウ										
19	ヒ	ツ	"	ケ	:	2	0	0	3	.	0	6	.	2	6	
20	シ	"	コ	ク	:						1	6	:	5	7	
21																
22	シ	ヨ	メ	イ												
23																
24																
25																
26	*	*	*	*	*	*	*	*	*	*	*	*	*	*	*	
27																
28																
29																
30																

(4) Span test with an external weight

English

1															
2	*	*	C	A	L	.	T	E	S	T	*	*	*	*	*
3															
4	D	A	T	E	:	2	0	0	3	.	0	6	.	2	6
5	T	I	M	E	:						1	6	:	5	6
6	S	H	I	N	K	O				D	E	N	S	H	I
7	T	Y	P	E	:										
8	X	X	X	X	X	X	H	J	R	-	1	7	K	C	E
9	S	/	N	:		X	X	X	X	X	X	X	X	X	X
10	I	D	:						X	X	X	X	X	X	X
11															
12	C	A	L	.	E	X	T	.	T	E	S	T			
13	R	E	F	:											
14			X	X	X	X	X	X	X	X	X	X	X		g
15	D	I	F	F	:										
16			X	X	X	X	X	X	X	X	X	X	X		g
17															
18	C	O	M	P	L	E	T	E							
19	D	A	T	E	:	2	0	0	3	.	0	6	.	2	6
20	T	I	M	E	:						1	6	:	5	7
21															
22	S	I	G	N	A	T	U	R	E						
23															
24															
25															
26	*	*	*	*	*	*	*	*	*	*	*	*	*	*	*
27															
28															
29															
30															

Japanese (Katakana)

1																
2	*	*	*						テ	ス	ト			*	*	*
3																
4	ヒ	ツ	"	ケ	:	2	0	0	3	.	0	6	.	2	6	
5	シ	"	コ	ク	:						1	6	:	5	6	
6	S	H	I	N	K	O				D	E	N	S	H	I	
7	カ	タ	シ	キ	:											
8	X	X	X	X	X	X	H	J	R	-	1	7	K	C	E	
9	セ	イ	ハ	"	ン	X	X	X	X	X	X	X	X	X	X	
10	I	D	:							X	X	X	X	X	X	
11																
12	テ	ス	ト	(カ	"	イ	フ	"	フ	ン	ト	"	ウ)	
13	キ	シ	"	ユ	ン	:										
14			X	X	X	X	X	X	X	X	X	X	X		g	
15	コ	"	サ	:												
16			X	X	X	X	X	X	X	X	X	X	X		g	
17																
18	シ	ユ	ウ	リ	ヨ	ウ										
19	ヒ	ツ	"	ケ	:	2	0	0	3	.	0	6	.	2	6	
20	シ	"	コ	ク	:						1	6	:	5	7	
21																
22	シ	ヨ	メ	イ												
23																
24																
25																
26	*	*	*	*	*	*	*	*	*	*	*	*	*	*	*	
27																
28																
29																
30																

(5) Calibration of the built-in weight

English

	1	2	3	4	5	6	7	8	9	10	11	12	13	14	15
1															
2	*	*	*	*	R	E	F	.	C	A	L	*	*	*	*
3															
4	D	A	T	E	:	2	0	0	3	.	0	6	.	2	6
5	T	I	M	E	:					1	6	:	5	6	
6	S	H	I	N	K	O				D	E	N	S	H	I
7	T	Y	P	E	:										
8	X	X	X	X	X	H	J	R	-	1	7	K	C	E	
9	S	/	N	:		X	X	X	X	X	X	X	X	X	X
10	I	D	:							X	X	X	X	X	X
11															
12	R	E	F	:											
13				X	X	X	X	X	X	X	X	X	X		g
14															
15	C	O	M	P	L	E	T	E							
16	D	A	T	E	:	2	0	0	3	.	0	6	.	2	6
17	T	I	M	E	:					1	6	:	5	8	
18															
19	S	I	G	N	A	T	U	R	E						
20															
21															
22															
23	*	*	*	*	*	*	*	*	*	*	*	*	*	*	*
24															
25															
26															
27															

Japanese (Katakana)

	1	2	3	4	5	6	7	8	9	10	11	12	13	14	15
1															
2	*	ナ	イ	フ	”	フ	ン	ト	”	ウ	コ	ウ	セ	イ	*
3															
4	ヒ	ツ	”	ケ	:	2	0	0	3	.	0	6	.	2	6
5	シ	”	コ	ク	:					1	6	:	5	6	
6	S	H	I	N	K	O				D	E	N	S	H	I
7	カ	タ	シ	キ	:										
8	X	X	X	X	X	H	J	R	-	1	7	K	C	E	
9	セ	イ	ハ	”	ン	X	X	X	X	X	X	X	X	X	X
10	I	D	:							X	X	X	X	X	X
11															
12	キ	シ	”	ユ	ン	:									
13				X	X	X	X	X	X	X	X	X	X		g
14															
15	シ	ユ	ウ	リ	ヨ	ウ									
16	ヒ	ツ	”	ケ	:	2	0	0	3	.	0	6	.	2	6
17	シ	”	コ	ク	:					1	6	:	5	8	
18															
19	シ	ヨ	メ	イ											
20															
21															
22															
23	*	*	*	*	*	*	*	*	*	*	*	*	*	*	*
24															
25															
26															
27															

(6) Printing of measurement data

1) Header

English

	1	2	3	4	5	6	7	8	9	10	11	12	13	14	15
1															
2	S	H	I	N	K	O				D	E	N	S	H	I
3	T	Y	P	E	:										
4	X	X	X	X	X	H	J	R	-	1	7	K	C	E	
5	S	/	N	:		X	X	X	X	X	X	X	X	X	X
6	I	D	:							X	X	X	X	X	X
7															
8	S	T	A	R	T										
9	D	A	T	E	:	2	0	0	3	.	0	6	.	2	6
10	T	I	M	E	:					1	6	:	5	5	
11															

Japanese (Katakana)

	1	2	3	4	5	6	7	8	9	10	11	12	13	14	15
1															
2	S	H	I	N	K	O				D	E	N	S	H	I
3	カ	タ	シ	キ	:										
4	X	X	X	X	X	H	J	R	-	1	7	K	C	E	
5	セ	イ	ハ	”	ン	X	X	X	X	X	X	X	X	X	X
6	I	D	:							X	X	X	X	X	X
7															
8	カ	イ	シ												
9	ヒ	ツ	”	ケ	:	2	0	0	3	.	0	6	.	2	6
10	シ	”	コ	ク	:					1	6	:	5	5	
11															

2) Footer

English

	1	2	3	4	5	6	7	8	9	10	11	12	13	14	15
1															
2	E	N	D												
3	D	A	T	E	:	2	0	0	3	.	0	6	.	2	6
4	T	I	M	E	:					1	6	:	5	6	
5															
6	S	I	G	N	A	T	U	R	E						
7															
8															
9															
10	*	*	*	*	*	*	*	*	*	*	*	*	*	*	*
11															
12															
13															
14															

Japanese (Katakana)

	1	2	3	4	5	6	7	8	9	10	11	12	13	14	15
1															
2	シ	ユ	ウ	リ	ヨ	ウ									
3	ヒ	ツ	”	ケ	:	2	0	0	3	.	0	6	.	2	6
4	シ	”	コ	ク	:					1	6	:	5	6	
5															
6	シ	ヨ	メ	イ											
7															
8															
9															
10	*	*	*	*	*	*	*	*	*	*	*	*	*	*	*
11															
12															
13															
14															





15 Operate on Batteries

This function can only be used with a balance equipped with optional batteries.

15.1 Specifications

- Battery built in
- Charge time: About 12 hours
- Operation time: About 6 hours of continuous operation
- Can be recharged: More than 300 times
- Minimum operating voltage 7V (The minimum of voltage which does not receive restriction in operation)

15.2 Recharging Batteries

- A [] icon is displayed when the balance is operated on batteries. As the batteries get weaker, the icon is changed from [] to [] (flashing). When the icon changes to [] (flashing), follow the steps below to charge the batteries.
 - (1) Connect the AC adapter supplied with the balance.
 - (2) Turn the balance off.
 - (3) Wait about 12 hours until the batteries are fully recharged.

15.3 Precautions Relating to Use

1. Disconnect the AC adapter after the batteries are recharged. The balance operated on batteries is slightly charged while it is in use (turned on). Do not continue to charge batteries after they are recharged, because that may shorten their life.
2. When you use the balance for the first time after you purchase it, battery operation time may be shorter than usual because of natural discharge.
3. If nothing is displayed or the display is turned off in a minute after you turn on the balance or the display is turned off after beep(PiPiPiPiPiPi) sound the batteries may be weak recharge the batteries or operate the balance on the AC adapter.
4. When changing to the [] mark, you cannot operate Span calibration, Span test and Built-in weight calibration used with the built-in weight. When you use a built-in weight, please charge or use it by AC adapter.



Caution

Follow the following instructions for safe use:

1. Do not disassemble or modify the batteries. Avoid the reverse wiring of positive and negative poles or a short circuit. Such mishandling may damage the batteries, or cause the balance to fail or ignite.
2. Be sure to use the AC adapter supplied with the balance. A different AC adapter may cause the batteries to generate heat or explode.
3. Do not put the batteries into a fire because they may explode.

16 Troubleshooting

* Parentheses contain a page to refer to.

Symptom	Cause	Measures to Take
The display indicates nothing.	<ul style="list-style-type: none"> The AC adapter is not connected. The batteries are exhausted. 	<p>→ Ensure that the AC adapter is connected.</p> <p>→ Recharge the batteries (page 59).</p>
<p>The display is unstable.</p> <p>The display takes time to be stabilized.</p> <p>The display does not move with the M sign flashing.</p>	<ul style="list-style-type: none"> The balance is influenced by wind or vibration. The balance is placed on an unstable base. The pan, tare, or sample put on the balance is in contact with an external object. The filter of the balance is clogged. 	<p>→ Read Precautions Relating to Use (page 2 to 4).</p> <p>→ Remove the rubber cap in the balance (page 61).</p>
Weight indication contains an error.	<ul style="list-style-type: none"> Tare range is set incorrectly. The adjusters are not settled, and the balance is not kept horizontal. The balance has not been used for a long period of time or the balance was relocated to a different area. 	<p>→ Set the tare range correctly.</p> <p>→ Check that the balance is kept horizontal (page 9).</p> <p>→ Perform span adjustment of the balance (page 34).</p>
[\square - E r r] appears before the capacity is reached.	<ul style="list-style-type: none"> Gross weight exceeded the capacity of the balance (weight range = container + weight of sample). A section of the mechanism is damaged. 	<p>→ Check the total weight.</p> <p>→ Execute tare subtraction again.</p> <p>→ Contact your local dealer.</p>
[\square - E r r] is displayed.	<ul style="list-style-type: none"> A foreign object is caught between the measuring pan (pan base) and the balance. A section of the mechanism is damaged. 	<p>→ Remove the measurement pan and examine the surface beneath it.</p> <p>→ Contact your local dealer.</p>
[\square - E r r] is displayed.	<ul style="list-style-type: none"> The internal clock has failed. 	<p>→ Contact your local dealer.</p>
<p>[\square - E r r] is displayed.</p> <p>[\square - E r r] is displayed.</p>	<ul style="list-style-type: none"> The balance is influenced by static electricity or noise. The electric components of the balance have failed. 	<p>→ Contact your local dealer.</p>
<p>The display is turned off when the balance is operated on batteries.</p> <p>The [\square] icon blinks.</p> <p>The display indicates nothing.</p>	<ul style="list-style-type: none"> The display was turned off by the auto power off function. The batteries were exhausted. 	<p>→ Turn the power on again. Disable the auto power off function if desired (page 38).</p> <p>→ Recharge the batteries (page 59).</p> <p>→ Operate the balance on the AC adapter.</p>
The displayed value [on 0] is blinking, and no further action occurs.	<ul style="list-style-type: none"> The object to be weighed is lying with its tare on the measuring pan. The weighing mechanism is damaged by some cause. 	<p>→ Remove all the objects on the measuring pan (page 11).</p> <p>→ Contact your local dealer.</p>
[\square - E r r] is displayed.	<ul style="list-style-type: none"> The built-in weight or drive unit has failed. 	<p>→ Contact your local dealer.</p>

Removing the rubber cap

If the balance takes longer than usual to be stabilized, the filter of the balance may be clogged.

In this case, remove the black rubber cap shown in the following figure for a quick fix. Force the cap open with a flathead screwdriver or a pair of pliers (The cap is somewhat difficult to remove to protect against dust and water).

If the problem is cleared by removing the rubber cap, replace the filter with a new one. If the problem is not cleared by removing the cap, it has been caused by another reason. Contact your local dealer.

Caution:

The balance no longer conforms to IP65 after the rubber cap is removed. When the cap is removed, protect the balance against dust or water drops.

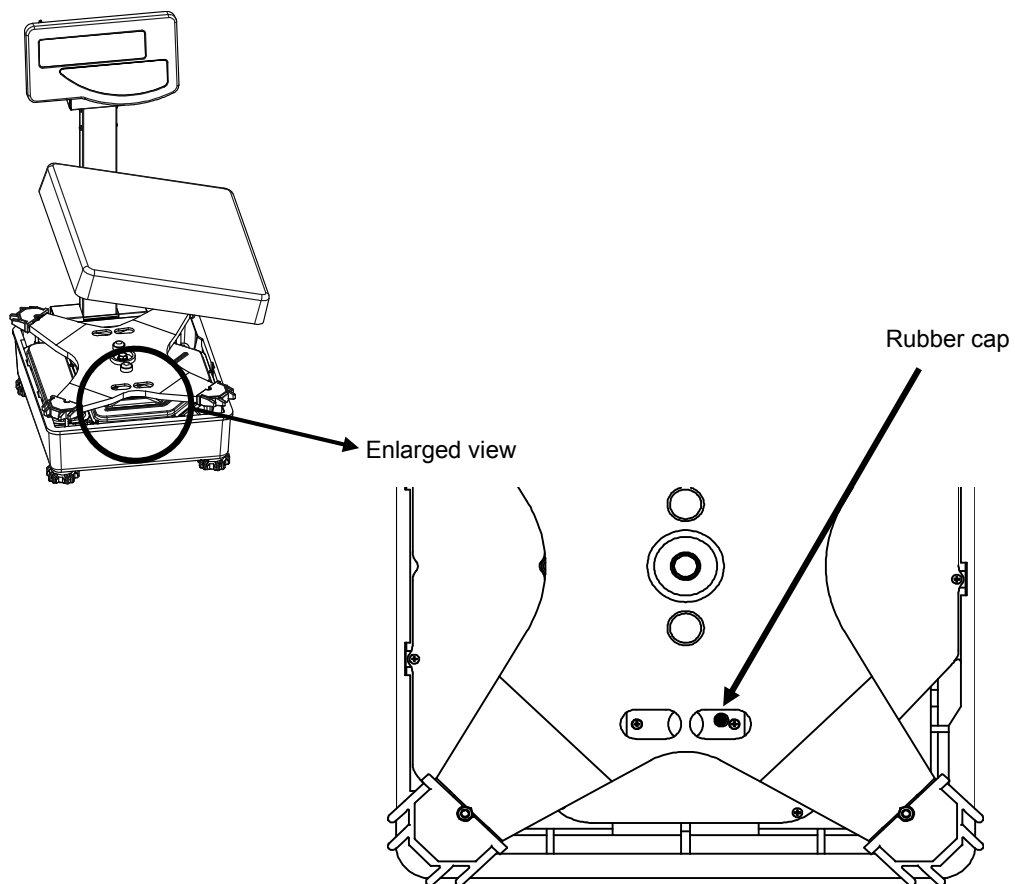

17. Specifications

17.1 Basic Specifications

Item \ Model	HJR-17K[S]CE	HJR-22K[S]CE	HJR-33K[S]CE	HJR-62KD[S]CE
Weighing capacity [g]	17000	22000	33000	62000
Minimum capacity [g]	5	5	5	5
Verification scale interval [g]	1	1	1	1
Actual scale interval [g]	0.1	0.1	0.1	0.1(0-6.2kg) 1(6.2-62kg)
Minimum unit weight (for parts counting)	0.1	0.1	0.1	0.1
Lower weight limit (for percent balance)	10	10	10	10
Switch between minimum readabilities	Auxiliary display			Double range
Calibration	Span adjustment with the built-in or an external weight			
OIML class	Class II			

Item \ Model	HJ-17K[S]CE	HJ-22K[S]CE	HJ-33K[S]CE	HJ-62KD[S]CE
Weighing capacity [g]	17000	22000	33000	62000
Minimum capacity [g]	5	5	5	5
Verification scale interval [g]	1	1	1	1
Actual scale interval [g]	0.1	0.1	0.1	0.1(0-6.2kg) 1(6.2-62kg)
Minimum unit weight (for parts counting)	0.1	0.1	0.1	0.1
Lower weight limit (for percent balance)	10	10	10	10
Switch between minimum readabilities	Auxiliary display			Double range
Calibration	Span adjustment with external weight			
OIML class	Class II			

17.2 Common Specifications

- (1) Weighing system Tuning fork system
- (2) Tare range Full capacity
- (3) Fluorescent display The FIP segment can display up to 8 digits.
The segment is 18 mm high, and displays 8 digits for a weight.
Can display a bar graph of up to 40 bars and various messages.
- (4) Display when overloaded A series of dots [$\square - \bar{E} r r$] is displayed when the weighing capacity is exceeded by 9 divisions.
- (5) Pan dimensions 400 × 350 [mm]
- (6) Dust- and water-proof Dust and water resistant to IP65*
- (7) Output Bi-direction RS232C output
Output for peripherals
- (8) Supported printer CSP-160, CSP-240
- (9) Temperature and humidity ranges ... 5 to 35°C, 80%RH or lower
- (10) AC adapter Dedicated AC adapter: DC12 V AC230 V
- (11) Options
 - 5 m PU cable (used to extend the balance cable)
 - 10 m PU cable (used to extend the balance cable)
(These optional PU cables are only available for the separate type.)
 - Hook for hanging
 - Battery option
 - Buzzer option
 - Limit contact output option
 - Full pack option
 - RS422 option
 - Pole kit for Separate type

* The balance is dust and water resistant to IP65 only when the connector cover is put on the display.

IP65 is a class of dustproof and waterproof structure. The 6 in IP65 indicates that the structure is completely dustproof, and the 5 indicates that the structure is resistant to water jets from all directions.

Caution:

1. Options other than the PU cables and the hook for hanging cannot be used in combination with each other.
2. When the RS422 option is selected, the D-SUB9P connector is replaced with an RS422 connector.
3. When you weigh a sample by hanging it, be careful to prevent dust or water from entering from the opening for the optional hook.

17.3 Weighing Capacity and Minimum Units of Different Units

Model Unit_of measurement	17KCE 17KSCE	22KCE 22KSCE	33KCE 33KSCE	62KDCE 62KDSCE
g	17000	22000	33000	62000
	1	1	1	1
	0.1	0.1	0.1	0.1
kg	17	22	33	62
	0.001	0.001	0.001	0.001
	0.0001	0.0001	0.0001	0.0001
ct (ct)	85000	110000	160000	310000
	5	5	5	5
	-	-	-	-

The view of the table

Top line:	Capacity
Middle line:	Verification scale interval
Bottom line:	Auxiliary scale interval

18. Conversion Table of Units

Unit	gram	kilogram	carat
1g	1	1000	5
1kg	0.001	1	0.005
1ct	0.2	200	1

